

Project Specific Water Quality Management Plan

A Template for Projects located within the **Santa Ana Watershed** Region of Riverside County

Project Title: Tract 38237

Development No:

Design Review/Case No:

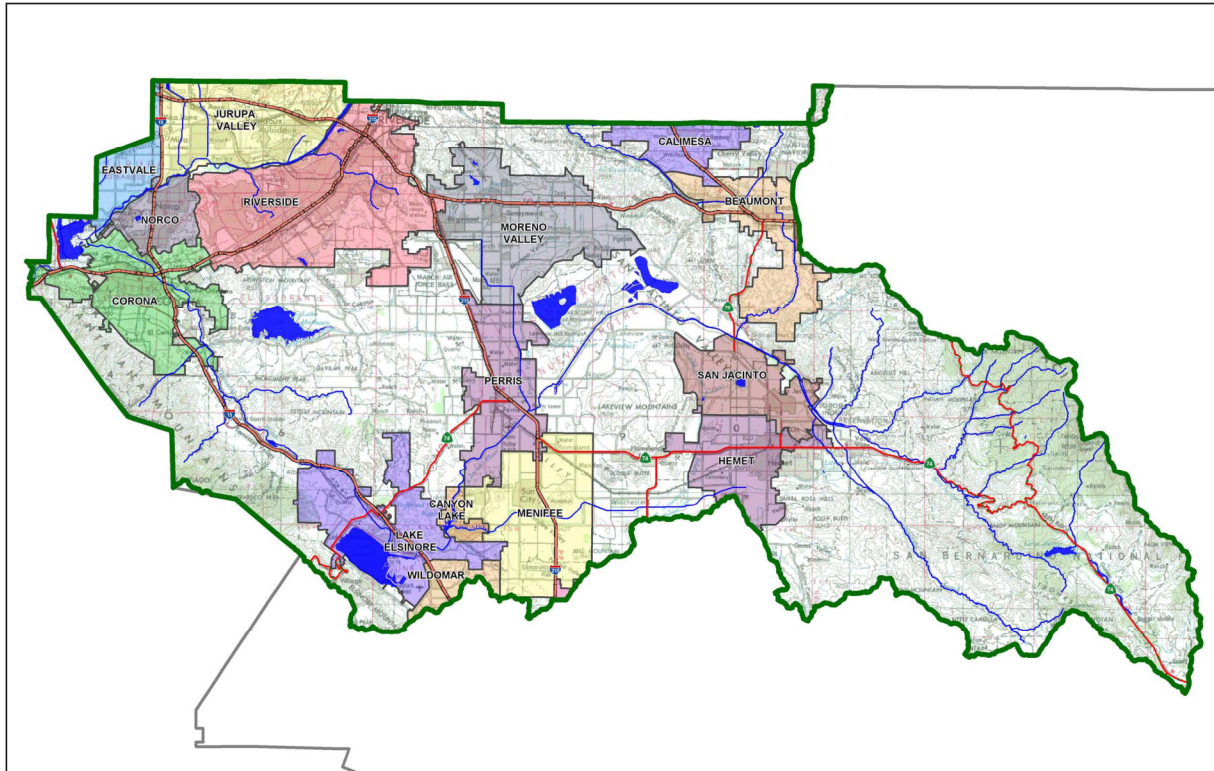

- Preliminary
- Final

Original Date Prepared: August 2021

Revision Date(s):

*Prepared for Compliance with
Regional Board Order No. **R8-2010-0033***

Template revised June 30, 2016

Prepared for:

D·R·HORTON
America's Builder

2280 Wardlow Circle, Suite 100
Corona, CA 92880
(951) 272-9000

Prepared by: Michael Brendecke

adkan
ENGINEERS

6879 Airport Drive
Riverside, CA 92504
Tel: (951) 688-0241

A Brief Introduction

This Project-Specific WQMP Template for the **Santa Ana Region** has been prepared to help guide you in documenting compliance for your project. Because this document has been designed to specifically document compliance, you will need to utilize the WQMP Guidance Document as your “how-to” manual to help guide you through this process. Both the Template and Guidance Document go hand-in-hand, and will help facilitate a well prepared Project-Specific WQMP. Below is a flowchart for the layout of this Template that will provide the steps required to document compliance.

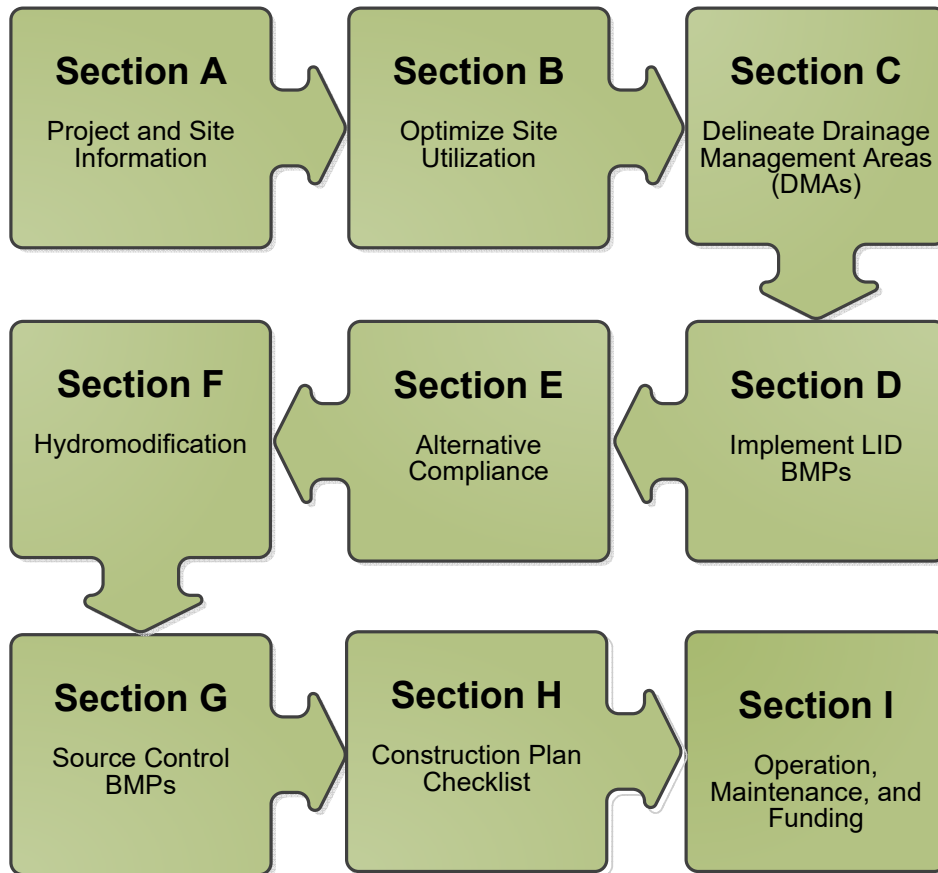

OWNER'S CERTIFICATION

This Project-Specific Water Quality Management Plan (WQMP) has been prepared for D.R. Horton by Adkan Engineers for Tract 38237 project.

This WQMP is intended to comply with the requirements of City of Moreno Valley which includes the requirement for the preparation and implementation of a Project-Specific WQMP.

The undersigned, while owning the property/project described in the preceding paragraph, shall be responsible for the implementation and funding of this WQMP and will ensure that this WQMP is amended as appropriate to reflect up-to-date conditions on the site. In addition, the property owner accepts responsibility for interim operation and maintenance of Stormwater BMPs until such time as this responsibility is formally transferred to a subsequent owner. This WQMP will be reviewed with the facility operator, facility supervisors, employees, tenants, maintenance and service contractors, or any other party (or parties) having responsibility for implementing portions of this WQMP. At least one copy of this WQMP will be maintained at the project site or project office in perpetuity. The undersigned is authorized to certify and to approve implementation of this WQMP. The undersigned is aware that implementation of this WQMP is enforceable under City of Moreno Valley Water Quality Ordinance (Municipal Code Section 9.10.080).

"I, the undersigned, certify under penalty of law that the provisions of this WQMP have been reviewed and accepted and that the WQMP will be transferred to future successors in interest."

Owner's Signature

Date

Owner's Printed Name

Owner's Title/Position

PREPARER'S CERTIFICATION

"The selection, sizing and design of stormwater treatment and other stormwater quality and quantity control measures in this plan meet the requirements of Regional Water Quality Control Board Order No. **R8-2010-0033** and any subsequent amendments thereto."

Preparer's Signature

Date

Michael Brendecke
Preparer's Printed Name

Project Manager
Preparer's Title/Position

Preparer's Licensure:



Table of Contents

Section A: Project and Site Information.....	6
A.1 Maps and Site Plans.....	6
A.2 Identify Receiving Waters.....	7
A.3 Additional Permits/Approvals required for the Project:	7
Section B: Optimize Site Utilization (LID Principles)	8
Section C: Delineate Drainage Management Areas (DMAs).....	9
Section D: Implement LID BMPs	11
D.1 Infiltration Applicability	11
D.2 Harvest and Use Assessment.....	12
D.3 Bioretention and Biotreatment Assessment	14
D.4 Feasibility Assessment Summaries	15
D.5 LID BMP Sizing	16
Section E: Alternative Compliance (LID Waiver Program)	17
E.1 Identify Pollutants of Concern	18
E.2 Stormwater Credits	19
E.3 Sizing Criteria.....	19
E.4 Treatment Control BMP Selection	20
Section F: Hydromodification	21
F.1 Hydrologic Conditions of Concern (HCOC) Analysis.....	21
F.2 HCOC Mitigation.....	22
Section G: Source Control BMPs.....	23
Section H: Construction Plan Checklist	25
Section I: Operation, Maintenance and Funding.....	26

List of Tables

Table A.1 Identification of Receiving Waters.....	7
Table A.2 Other Applicable Permits.....	7
Table C.1 DMA Classifications.....	9
Table C.2 Type 'A', Self-Treating Areas.....	9
Table C.3 Type 'B', Self-Retaining Areas.....	9
Table C.4 Type 'C', Areas that Drain to Self-Retaining Areas.....	10
Table C.5 Type 'D', Areas Draining to BMPs.....	10
Table D.1 Infiltration Feasibility.....	11
Table D.2 LID Prioritization Summary Matrix.....	15
Table D.3 DCV Calculations for LID BMPs.....	16
Table E.1 Potential Pollutants by Land Use Type.....	18
Table E.2 Water Quality Credits.....	19
Table E.3 Treatment Control BMP Sizing.....	19
Table E.4 Treatment Control BMP Selection.....	20
Table F.1 Hydrologic Conditions of Concern Summary.....	21
Table G.1 Permanent and Operational Source Control Measures.....	24
Table H.1 Construction Plan Cross-reference.....	25

List of Appendices

Appendix 1: Maps and Site Plans.....	27
Appendix 2: Construction Plans.....	28
Appendix 3: Soils Information.....	29
Appendix 4: Historical Site Conditions.....	30
Appendix 5: LID Infeasibility.....	31
Appendix 6: BMP Design Details.....	32
Appendix 7: Hydromodification.....	33
Appendix 8: Source Control.....	34
Appendix 9: O&M.....	35
Appendix 10: Educational Materials.....	37

Section A: Project and Site Information

PROJECT INFORMATION	
Type of Project:	Residential
Planning Area:	Residential
Community Name:	Moreno Valley
Development Name:	Tract 38236
PROJECT LOCATION	
Latitude & Longitude (DMS): 33.914688, -117.181669	
Project Watershed and Sub-Watershed: Santa Ana River	
Gross Acres: 8.80 +/-	
APN(s): 486-240-010	
Map Book and Page No.: MB 11/10 SB Bear Valley & Alessandro Development Co.	
PROJECT CHARACTERISTICS	
Proposed or Potential Land Use(s)	R5 Residential
Proposed or Potential SIC Code(s)	1522
Area of Impervious Project Footprint (SF)	247,628 SF
Total Area of <u>proposed</u> Impervious Surfaces within the Project Footprint (SF)/or Replacement	247,628 SF
Does the project consist of offsite road improvements?	<input type="checkbox"/> Y <input checked="" type="checkbox"/> N
Does the project propose to construct unpaved roads?	<input type="checkbox"/> Y <input checked="" type="checkbox"/> N
Is the project part of a larger common plan of development (phased project)?	<input type="checkbox"/> Y <input checked="" type="checkbox"/> N
EXISTING SITE CHARACTERISTICS	
Total area of <u>existing</u> Impervious Surfaces within the Project limits Footprint (SF)	0 sf
Is the project located within any MSHCP Criteria Cell?	<input type="checkbox"/> Y <input checked="" type="checkbox"/> N
If so, identify the Cell number:	N/A
Are there any natural hydrologic features on the project site?	<input type="checkbox"/> Y <input checked="" type="checkbox"/> N
Is a Geotechnical Report attached?	<input checked="" type="checkbox"/> Y <input type="checkbox"/> N
If no Geotech. Report, list the NRCS soils type(s) present on the site (A, B, C and/or D)	B
What is the Water Quality Design Storm Depth for the project?	0.70

The planned development will consist of 67 single-family residences, street improvements, and 2 onsite stormwater treatment areas (Bio-retention basins). They are at the intersection of Oliver Street and Brodiaea Avenue and between Lot 47 & 48. Offsite street improvements will be done on Oliver Street and Brodiaea Avenue in order to build out ultimate curb and gutter along the project frontage. All onsite runoff will flow to the south as per the existing drainage path.

A.1 Maps and Site Plans

When completing your Project-Specific WQMP, include a map of the local vicinity and existing site. In addition, include all grading, drainage, landscape/plant palette and other pertinent construction plans in Appendix 2. At a **minimum**, your WQMP Site Plan should include the following:

- Drainage Management Areas
- Proposed Structural BMPs
- Drainage Path
- Drainage Infrastructure, Inlets, Overflows
- Source Control BMPs
- Buildings, Roof Lines, Downspouts
- Impervious Surfaces
- Standard Labeling
- BMP Locations (Lat/Long)

A.1 Identify Receiving Waters

Using Table A.1 below, list in order of upstream to downstream, the receiving waters that the project site is tributary to. Continue to fill each row with the Receiving Water's 303(d) listed impairments (if any), designated beneficial uses, and proximity, if any, to a RARE beneficial use. Include a map of the receiving waters in Appendix 1.

Table A.1 Identification of Receiving Waters

Receiving Waters	EPA Approved 303(d) List Impairments	Designated Beneficial Uses	Proximity to RARE Beneficial Use
Moreno Valley Storm Drain	N/A	N/A	Not a RARE water body
Perris Valley Channel	N/A	N/A	Not a RARE water body
San Jacinto River Reach 3	None	MUN, AGR, GWR, REC1, REC2, WARM, WILD	MUN, AGR, GWR, REC1, REC2, WARM, WILD
Canyon Lake (Railroad Canyon Reservoir)	Pathogens, Nutrients	MUN, AGR, GWR, REC1, REC2, WARM, WILD	Not a RARE water body
San Jacinto River Reach 1	None	MUN, AGR, GWR, REC1, REC2, WARM, WILD	MUN, AGR, GWR, REC1, REC2, WARM, WILD
Lake Elsinore	Nutrients, Organic Enrichment/Low Dissolved Oxygen	REC1, REC2, WARM, WILD	Not a RARE water body

A.2 Additional Permits/Approvals required for the Project:

Table A.2 Other Applicable Permits

Agency	Permit Required	
State Department of Fish and Game, 1602 Streambed Alteration Agreement	<input type="checkbox"/> Y	<input checked="" type="checkbox"/> N
State Water Resources Control Board, Clean Water Act (CWA) Section 401 Water Quality Cert.	<input type="checkbox"/> Y	<input checked="" type="checkbox"/> N
US Army Corps of Engineers, CWA Section 404 Permit	<input type="checkbox"/> Y	<input checked="" type="checkbox"/> N
US Fish and Wildlife, Endangered Species Act Section 7 Biological Opinion	<input type="checkbox"/> Y	<input checked="" type="checkbox"/> N
Statewide Construction General Permit Coverage	<input checked="" type="checkbox"/> Y	<input type="checkbox"/> N
Statewide Industrial General Permit Coverage	<input type="checkbox"/> Y	<input checked="" type="checkbox"/> N
Western Riverside MSHCP Consistency Approval (e.g., JPR, DBESP)	<input type="checkbox"/> Y	<input checked="" type="checkbox"/> N
Other (please list in the space below as required) City of Moreno Valley Grading permits, encroachment permits	<input checked="" type="checkbox"/> Y	<input type="checkbox"/> N

If yes is answered to any of the questions above, the Co-Permittee may require proof of approval/coverage from those agencies as applicable including documentation of any associated requirements that may affect this Project-Specific WQMP.

Section B: Optimize Site Utilization (LID Principles)

Review of the information collected in Section 'A' will aid in identifying the principal constraints on site design and selection of LID BMPs as well as opportunities to reduce imperviousness and incorporate LID Principles into the site and landscape design. For example, **constraints** might include impermeable soils, high groundwater, groundwater pollution or contaminated soils, steep slopes, geotechnical instability, high-intensity land use, heavy pedestrian or vehicular traffic, utility locations or safety concerns. **Opportunities** might include existing natural areas, low areas, oddly configured or otherwise unbuildable parcels, easements and landscape amenities including open space and buffers (which can double as locations for bioretention BMPs), and differences in elevation (which can provide hydraulic head). Prepare a brief narrative for each of the site optimization strategies described below. This narrative will help you as you proceed with your LID design and explain your design decisions to others. The 2010 Santa Ana MS4 Permit further requires that LID Retention BMPs (Infiltration Only or Harvest and Use) be used unless it can be shown that those BMPs are infeasible. Therefore, it is important that your narrative identify and justify if there are any constraints that would prevent the use of those categories of LID BMPs. Similarly, you should also note opportunities that exist which will be utilized during project design. Upon completion of identifying Constraints and Opportunities, include these on your WQMP Site plan in Appendix 1.

Consideration of "highest and best use" of the discharge should also be considered. For example, Lake Elsinore is evaporating faster than runoff from natural precipitation can recharge it. Requiring infiltration of 85% of runoff events for projects tributary to Lake Elsinore would only exacerbate current water quality problems associated with Pollutant concentration due to lake water evaporation. In cases where rainfall events have low potential to recharge Lake Elsinore (i.e. no hydraulic connection between groundwater to Lake Elsinore, or other factors), requiring infiltration of Urban Runoff from projects is counterproductive to the overall watershed goals. Project proponents, in these cases, would be allowed to discharge Urban Runoff, provided they used equally effective filtration-based BMPs.

Site Optimization

The following questions are based upon Section 3.2 of the WQMP Guidance Document. Review of the WQMP Guidance Document will help you determine how best to optimize your site and subsequently identify opportunities and/or constraints, and document compliance.

Did you identify and preserve existing drainage patterns? If so, how? If not, why?

Yes, existing drainage patterns on site drain all runoff from the north to the southwest. The proposed design uses catch basins to direct the flow into 2 proposed Bio-Retention Basins for treatment prior to draining into the existing MDP line near Oliver Street.

Did you identify and protect existing vegetation? If so, how? If not, why?

No, existing natural vegetation will not be protected. All vegetation will be removed.

Did you identify and preserve natural infiltration capacity? If so, how? If not, why?

No, natural infiltration will not be used due to rates a below the minimum required infiltration rate.

Did you identify and minimize impervious area? If so, how? If not, why?

No, site design will be typical for this type of development.

Did you identify and disperse runoff to adjacent pervious areas? If so, how? If not, why?

Yes, roof runoff from proposed homes will flow through landscape all other flows will drain to the 2 proposed Bio-Retention Basins for treatment prior to draining into the existing MDP line near Oliver Street.

Section C: Delineate Drainage Management Areas (DMAs)

Utilizing the procedure in Section 3.3 of the WQMP Guidance Document which discusses the methods of delineating and mapping your project site into individual DMAs, complete Table C.1 below to appropriately categorize the types of classification (e.g., Type A, Type B, etc.) per DMA for your project site. Upon completion of this table, this information will then be used to populate and tabulate the corresponding tables for their respective DMA classifications.

Table C.1 DMA Classifications

DMA Name or ID	Surface Type(s) ¹²	Area (Sq. Ft.)	DMA Type
D.1.1	Roof/ Landscape	141,359	D
D.1.2	Concrete / Asphalt	71,799	D
D.1.3	Landscaping	24,330	D
D.2.1	Roof/ Landscape	127,505	D
D.2.2	Concrete / Asphalt	41,396	D
D.2.3	Concrete / Asphalt	25,792	D

¹Reference Table 2-1 in the WQMP Guidance Document to populate this column

²If multi-surface provide back-up

Table C.2 Type 'A', Self-Treating Areas

DMA Name or ID	Area (Sq. Ft.)	Stabilization Type	Irrigation Type (if any)

Table C.3 Type 'B', Self-Retaining Areas

Self-Retaining Area				Type 'C' DMAs that are draining to the Self-Retaining Area		
DMA Name/ ID	Post-project surface type	Area (square feet)	Storm Depth (inches)	DMA Name / ID	[C] from Table C.4 = [C]	Required Retention Depth (inches)
		[A]	[B]			[D]

$$[D] = [B] + \frac{[B] \cdot [C]}{[A]}$$

Table C.4 Type 'C', Areas that Drain to Self-Retaining Areas

DMA					Receiving Self-Retaining DMA		
DMA Name/ ID	Area (square feet)	Post-project surface type	Impervious fraction	Product	DMA name /ID	Area (square feet)	Ratio
	[A]		[B]			[C] = [A] x [B]	[D]

Table C.5 Type 'D', Areas Draining to BMPs

DMA Name or ID	BMP Name or ID
D.1.1	Bio-Retention Basin
D.1.2	Bio-Retention Basin
D.1.3	Bio-Retention Basin
D.2.1	Bio-Retention Basin
D.2.2	Bio-Retention Basin
D.2.3	Bio-Retention Basin

Note: More than one drainage management area can drain to a single LID BMP, however, one drainage management area may not drain to more than one BMP.

Section D: Implement LID BMPs

D.1 Infiltration Applicability

Is there an approved downstream ‘Highest and Best Use’ for stormwater runoff (see discussion in Chapter 2.4.4 of the WQMP Guidance Document for further details)? Y N

If yes has been checked, Infiltration BMPs shall not be used for the site; proceed to section D.3

If no, continue working through this section to implement your LID BMPs. It is recommended that you contact your Co-Permittee to verify whether or not your project discharges to an approved downstream ‘Highest and Best Use’ feature.

Geotechnical Report

A Geotechnical Report or Phase I Environmental Site Assessment may be required by the Copermitee to confirm present and past site characteristics that may affect the use of Infiltration BMPs. In addition, the Co-Permittee, at their discretion, may not require a geotechnical report for small projects as described in Chapter 2 of the WQMP Guidance Document. If a geotechnical report has been prepared, include it in Appendix 3. In addition, if a Phase I Environmental Site Assessment has been prepared, include it in Appendix 4.

Is this project classified as a small project consistent with the requirements of Chapter 2 of the WQMP Guidance Document? Y N

Infiltration Feasibility

Table D.1 below is meant to provide a simple means of assessing which DMAs on your site support Infiltration BMPs and is discussed in the WQMP Guidance Document in Chapter 2.4.5. Check the appropriate box for each question and then list affected DMAs as applicable. If additional space is needed, add a row below the corresponding answer.

Table D.1 Infiltration Feasibility

Does the project site...	YES	NO
...have any DMAs with a seasonal high groundwater mark shallower than 10 feet? If Yes, list affected DMAs:		X
...have any DMAs located within 100 feet of a water supply well? If Yes, list affected DMAs:		X
...have any areas identified by the geotechnical report as posing a public safety risk where infiltration of stormwater could have a negative impact? If Yes, list affected DMAs:		X
...have measured in-situ infiltration rates of less than 1.6 inches / hour? If Yes, list affected DMAs:	X	
...have significant cut and/or fill conditions that would preclude in-situ testing of infiltration rates at the final infiltration surface? If Yes, list affected DMAs:		X
...geotechnical report identify other site-specific factors that would preclude effective and safe infiltration? Describe here:		X

If you answered “Yes” to any of the questions above for any DMA, Infiltration BMPs should not be used for those DMAs and you should proceed to the assessment for Harvest and Use below.

D.2 Harvest and Use Assessment

Please check what applies:

- Reclaimed water will be used for the non-potable water demands for the project.
- Downstream water rights may be impacted by Harvest and Use as approved by the Regional Board (verify with the Copermittee).
- The Design Capture Volume will be addressed using Infiltration Only BMPs. In such a case, Harvest and Use BMPs are still encouraged, but it would not be required if the Design Capture Volume will be infiltrated or evapotranspired.
- None of the above

If any of the above boxes have been checked, Harvest and Use BMPs need not be assessed for the site. If none of the above criteria applies, follow the steps below to assess the feasibility of irrigation use, toilet use and other non-potable uses (e.g., industrial use).

Design of the Drainage Plan Line H-2 downstream of Tr 31590 was designed to account for future developed run-on flows from Tr 31590. Because of this design, capturing flows from Tr 31590 as Harvest and Reuse may impact downstream water rights. Therefore, onsite flows for Tr 31590 are proposed to be treated, but will not be detained on site.

Irrigation Use Feasibility

Complete the following steps to determine the feasibility of harvesting stormwater runoff for Irrigation Use BMPs on your site:

Step 1: Identify the total area of irrigated landscape on the site, and the type of landscaping used.

Total Area of Irrigated Landscape: N/A

Type of Landscaping (Conservation Design or Active Turf): N/A

Step 2: Identify the planned total of all impervious areas on the proposed project from which runoff might be feasibly captured and stored for irrigation use. Depending on the configuration of buildings and other impervious areas on the site, you may consider the site as a whole, or parts of the site, to evaluate reasonable scenarios for capturing and storing runoff and directing the stored runoff to the potential use(s) identified in Step 1 above.

Total Area of Impervious Surfaces: N/A

Step 3: Cross reference the Design Storm depth for the project site (see Exhibit A of the WQMP Guidance Document) with the left column of Table 2-3 in Chapter 2 to determine the minimum area of Effective Irrigated Area per Tributary Impervious Area (EIATIA).

Enter your EIATIA factor: N/A

Step 4: Multiply the unit value obtained from Step 3 by the total of impervious areas from Step 2 to develop the minimum irrigated area that would be required.

Minimum required irrigated area: N/A

Step 5: Determine if harvesting stormwater runoff for irrigation use is feasible for the project by comparing the total area of irrigated landscape (Step 1) to the minimum required irrigated area (Step 4).

Minimum required irrigated area (Step 4)	Available Irrigated Landscape (Step 1)
N/A	N/A

Toilet Use Feasibility

Complete the following steps to determine the feasibility of harvesting stormwater runoff for toilet flushing uses on your site:

Step 1: Identify the projected total number of daily toilet users during the wet season, and account for any periodic shut downs or other lapses in occupancy:

Projected Number of Daily Toilet Users: N/A

Project Type: N/A

Step 2: Identify the planned total of all impervious areas on the proposed project from which runoff might be feasibly captured and stored for toilet use. Depending on the configuration of buildings and other impervious areas on the site, you may consider the site as a whole, or parts of the site, to evaluate reasonable scenarios for capturing and storing runoff and directing the stored runoff to the potential use(s) identified in Step 1 above.

Total Area of Impervious Surfaces: N/A

Step 3: Enter the Design Storm depth for the project site (see Exhibit A) into the left column of Table 2-2 in Chapter 2 to determine the minimum number of toilet users per tributary impervious acre (TUTIA).

Enter your TUTIA factor: N/A

Step 4: Multiply the unit value obtained from Step 3 by the total of impervious areas from Step 2 to develop the minimum number of toilet users that would be required.

Minimum number of toilet users: N/A

Step 5: Determine if harvesting stormwater runoff for toilet flushing use is feasible for the project by comparing the Number of Daily Toilet Users (Step 1) to the minimum required number of toilet users (Step 4).

Minimum required Toilet Users (Step 4)	Projected number of toilet users (Step 1)
N/A	N/A

Other Non-Potable Use Feasibility

Are there other non-potable uses for stormwater runoff on the site (e.g. industrial use)? See Chapter 2 of the Guidance for further information. If yes, describe below. If no, write N/A.

N/A

Step 1: Identify the projected average daily non-potable demand, in gallons per day, during the wet season and accounting for any periodic shut downs or other lapses in occupancy or operation.

Average Daily Demand: N/A

Step 2: Identify the planned total of all impervious areas on the proposed project from which runoff might be feasibly captured and stored for the identified non-potable use. Depending on the configuration of buildings and other impervious areas on the site, you may consider the site as a whole, or parts of the site, to evaluate reasonable scenarios for capturing and storing runoff and directing the stored runoff to the potential use(s) identified in Step 1 above.

Total Area of Impervious Surfaces: N/A

Step 3: Enter the Design Storm depth for the project site (see Exhibit A) into the left column of Table 2-4 in Chapter 2 to determine the minimum demand for non-potable uses per tributary impervious acre.

Enter the factor from Table 2-4: N/A

Step 4: Multiply the unit value obtained from Step 3 by the total of impervious areas from Step 2 to develop the minimum number of gallons per day of non-potable use that would be required.

Minimum required use: N/A

Step 5: Determine if harvesting stormwater runoff for other non-potable use is feasible for the project by comparing the projected average daily use (Step 1) to the minimum required non-potable use (Step 4).

Minimum required non-potable use (Step 4)	Projected average daily use (Step 1)
N/A	N/A

If Irrigation, Toilet and Other Use feasibility anticipated demands are less than the applicable minimum values, Harvest and Use BMPs are not required and you should proceed to utilize LID Bioretention and Biotreatment per Section 3.4.2 of the WQMP Guidance Document.

D.3 Bioretention and Biotreatment Assessment

Other LID Bioretention and Biotreatment BMPs as described in Chapter 2.4.7 of the WQMP Guidance Document are feasible on nearly all development sites with sufficient advance planning.

Select one of the following:

LID Bioretention/Biotreatment BMPs will be used for some or all DMAs of the project as noted below in Section D.4 (note the requirements of Section 3.4.2 in the WQMP Guidance Document).

A site-specific analysis demonstrating the technical infeasibility of all LID BMPs has been performed and is included in Appendix 5. If you plan to submit an analysis demonstrating the technical infeasibility of LID BMPs, request a pre-submittal meeting with the Copermittee to discuss this option. Proceed to Section E to document your alternative compliance measures.

D.4 Feasibility Assessment Summaries

From the Infiltration, Harvest and Use, Bioretention and Biotreatment Sections above, complete Table D.2 below to summarize which LID BMPs are technically feasible, and which are not, based upon the established hierarchy.

Table D.2 LID Prioritization Summary Matrix

DMA Name/ID	LID BMP Hierarchy				No LID (Alternative Compliance)
	1. Infiltration	2. Harvest and use	3. Bioretention	4. Biotreatment	
D.1.1	<input type="checkbox"/>	<input type="checkbox"/>	<input checked="" type="checkbox"/>	<input type="checkbox"/>	<input type="checkbox"/>
D.1.2	<input type="checkbox"/>	<input type="checkbox"/>	<input checked="" type="checkbox"/>	<input type="checkbox"/>	<input type="checkbox"/>
D.1.3	<input type="checkbox"/>	<input type="checkbox"/>	<input checked="" type="checkbox"/>	<input type="checkbox"/>	<input type="checkbox"/>
D.2.1	<input type="checkbox"/>	<input type="checkbox"/>	<input checked="" type="checkbox"/>	<input type="checkbox"/>	<input type="checkbox"/>
D.2.2	<input type="checkbox"/>	<input type="checkbox"/>	<input checked="" type="checkbox"/>	<input type="checkbox"/>	<input type="checkbox"/>
D.2.3	<input type="checkbox"/>	<input type="checkbox"/>	<input checked="" type="checkbox"/>	<input type="checkbox"/>	<input type="checkbox"/>

For those DMAs where LID BMPs are not feasible, provide a brief narrative below summarizing why they are not feasible, include your technical infeasibility criteria in Appendix 5, and proceed to Section E below to document Alternative Compliance measures for those DMAs. Recall that each proposed DMA must pass through the LID BMP hierarchy before alternative compliance measures may be considered.

D.5 LID BMP Sizing

Each LID BMP must be designed to ensure that the Design Capture Volume will be addressed by the selected BMPs. First, calculate the Design Capture Volume for each LID BMP using the V_{BMP} worksheet in Appendix F of the LID BMP Design Handbook. Second, design the LID BMP to meet the required V_{BMP} using a method approved by the Copermittee. Utilize the worksheets found in the LID BMP Design Handbook or consult with your Copermittee to assist you in correctly sizing your LID BMPs. Complete Table D.3 below to document the Design Capture Volume and the Proposed Volume for each LID BMP. Provide the completed design procedure sheets for each LID BMP in Appendix 6. You may add additional rows to the table below as needed.

Table D.3 DCV Calculations for LID BMPs

DMA Type/ID	DMA Area (square feet)	Post-Project Surface Type	Effective Impervious Fraction, I_f	DMA Runoff Factor	DMA Areas \times Runoff Factor	Enter BMP Name / Identifier Here		
	[A]		[B]	[C]	[A] \times [C]			
D.1.1	141,359	Mixed Surface Types	0.5	0.34	47,956.00	Design Storm Depth (in)	Design Capture Volume, V_{BMP} (cubic feet)	Proposed Volume on Plans (cubic feet)
D.1.2	71,799	Roofs	1.0	0.89	64,044.70			
D.1.3	24,330	Lot Landscaping	0.1	0.11	2,687.40			
	237,488				114,688.10	0.70	6,690.10	6,690.10

DMA Type/ID	DMA Area (square feet)	Post-Project Surface Type	Effective Impervious Fraction, I_f	DMA Runoff Factor	DMA Areas \times Runoff Factor	Enter BMP Name / Identifier Here		
	[A]		[B]	[C]	[A] \times [C]			
D.2.1	127,505	Mixed Surface Types	0.5	0.34	43,256.10	Design Storm Depth (in)	Design Capture Volume, V_{BMP} (cubic feet)	Proposed Volume on Plans (cubic feet)
D.2.2	41,396	Roofs	1.0	0.89	36,925.20			
D.2.3	25,792	Lot Landscaping	0.1	0.11	2,848.90			
	194,693				83,030.20	0.70	4,843.40	4,843.40

[B], [C] is obtained as described in Section 2.3.1 of the WQMP Guidance Document

[E] is obtained from Exhibit A in the WQMP Guidance Document

[G] is obtained from a design procedure sheet, such as in LID BMP Design Handbook and placed in Appendix 6

Section E: Alternative Compliance (LID Waiver Program)

LID BMPs are expected to be feasible on virtually all projects. Where LID BMPs have been demonstrated to be infeasible as documented in Section D, other Treatment Control BMPs must be used (subject to LID waiver approval by the Copermittee). Check one of the following Boxes:

LID Principles and LID BMPs have been incorporated into the site design to fully address all Drainage Management Areas. No alternative compliance measures are required for this project and thus this Section is not required to be completed.

- Or -

The following Drainage Management Areas are unable to be addressed using LID BMPs. A site-specific analysis demonstrating technical infeasibility of LID BMPs has been approved by the Co-Permittee and included in Appendix 5. Additionally, no downstream regional and/or sub-regional LID BMPs exist or are available for use by the project. The following alternative compliance measures on the following pages are being implemented to ensure that any pollutant loads expected to be discharged by not incorporating LID BMPs, are fully mitigated.

E.1 Identify Pollutants of Concern

Utilizing Table A.1 from Section A above which noted your project's receiving waters and their associated EPA approved 303(d) listed impairments, cross reference this information with that of your selected Priority Development Project Category in Table E.1 below. If the identified General Pollutant Categories are the same as those listed for your receiving waters, then these will be your Pollutants of Concern and the appropriate box or boxes will be checked on the last row. The purpose of this is to document compliance and to help you appropriately plan for mitigating your Pollutants of Concern in lieu of implementing LID BMPs.

Table E.1 Potential Pollutants by Land Use Type

Priority Development Project Categories and/or Project Features (check those that apply)	General Pollutant Categories							
	Bacterial Indicators	Metals	Nutrients	Pesticides	Toxic Organic Compounds	Sediments	Trash & Debris	Oil & Grease
<input checked="" type="checkbox"/> Detached Residential Development	P	N	P	P	N	P	P	P
<input type="checkbox"/> Attached Residential Development	P	N	P	P	N	P	P	P ⁽²⁾
<input type="checkbox"/> Commercial/Industrial Development	P ⁽³⁾	P	P ⁽¹⁾	P ⁽¹⁾	P ⁽⁵⁾	P ⁽¹⁾	P	P
<input type="checkbox"/> Automotive Repair Shops	N	P	N	N	P ^(4, 5)	N	P	P
<input type="checkbox"/> Restaurants (>5,000 ft ²)	P	N	N	N	N	N	P	P
<input type="checkbox"/> Hillside Development (>5,000 ft ²)	P	N	P	P	N	P	P	P
<input type="checkbox"/> Parking Lots (>5,000 ft ²)	P ⁽⁶⁾	P	P ⁽¹⁾	P ⁽¹⁾	P ⁽⁴⁾	P ⁽¹⁾	P	P
<input type="checkbox"/> Retail Gasoline Outlets	N	P	N	N	P	N	P	P
Project Priority Pollutant(s) of Concern	<input checked="" type="checkbox"/>	<input type="checkbox"/>	<input checked="" type="checkbox"/>	<input checked="" type="checkbox"/>	<input type="checkbox"/>	<input checked="" type="checkbox"/>	<input checked="" type="checkbox"/>	<input checked="" type="checkbox"/>

P = Potential

N = Not Potential

⁽¹⁾ *A potential Pollutant if non-native landscaping exists or is proposed onsite; otherwise not expected*

⁽²⁾ *A potential Pollutant if the project includes uncovered parking areas; otherwise not expected*

⁽³⁾ *A potential Pollutant is land use involving animal waste*

⁽⁴⁾ *Specifically petroleum hydrocarbons*

⁽⁵⁾ *Specifically solvents*

⁽⁶⁾ *Bacterial indicators are routinely detected in pavement runoff*

E.2 Stormwater Credits

Projects that cannot implement LID BMPs but nevertheless implement smart growth principles are potentially eligible for Stormwater Credits. Utilize Table 3-8 within the WQMP Guidance Document to identify your Project Category and its associated Water Quality Credit. If not applicable, write N/A.

Table E.2 Water Quality Credits

Qualifying Project Categories	Credit Percentage ²
<i>Total Credit Percentage¹</i>	

¹Cannot Exceed 50%

²Obtain corresponding data from Table 3-8 in the WQMP Guidance Document

E.3 Sizing Criteria

After you appropriately considered Stormwater Credits for your project, utilize Table E.3 below to appropriately size them to the DCV, or Design Flow Rate, as applicable. Please reference Chapter 3.5.2 of the WQMP Guidance Document for further information.

Table E.3 Treatment Control BMP Sizing

DMA Type/ID	DMA Area (square feet)	Post-Project Surface Type	Effective Impervious Fraction, I _f	DMA Runoff Factor	DMA Area x Runoff Factor	Enter BMP Name / Identifier Here				
	[A]		[B]	[C]	[A] x [C]					
						Design Storm Depth (in)	Minimum Design Capture Volume or Design Flow Rate (cubic feet or cfs)	Total Storm Water Credit % Reduction	Proposed Volume or Flow on Plans (cubic feet or cfs)	
	$\sum A_T = \sum [A]$				$\Sigma = [D]$	[E]	$[F] = \frac{[D] \times [E]}{[G]}$	$[F] \times (1 - [H])$	[I]	

[B], [C] is obtained as described in Section 2.3.1 from the WQMP Guidance Document

[E] is for Flow-Based Treatment Control BMPs [E] = .2, for Volume-Based Control Treatment BMPs, [E] obtained from Exhibit A in the WQMP Guidance Document

[G] is for Flow-Based Treatment Control BMPs [G] = 43,560, for Volume-Based Control Treatment BMPs, [G] = 12

[H] is from the Total Credit Percentage as Calculated from Table E.2 above

[I] as obtained from a design procedure sheet from the BMP manufacturer and should be included in Appendix 6

E.4 Treatment Control BMP Selection

Treatment Control BMPs typically provide proprietary treatment mechanisms to treat potential pollutants in runoff, but do not sustain significant biological processes. Treatment Control BMPs must have a removal efficiency of a medium or high effectiveness as quantified below:

- **High:** equal to or greater than 80% removal efficiency
- **Medium:** between 40% and 80% removal efficiency

Such removal efficiency documentation (e.g., studies, reports, etc.) as further discussed in Chapter 3.5.2 of the WQMP Guidance Document, must be included in Appendix 6. In addition, ensure that proposed Treatment Control BMPs are properly identified on the WQMP Site Plan in Appendix 1.

Table E.4 Treatment Control BMP Selection

Selected Treatment Control BMP Name or ID ¹	Priority Pollutant(s) of Concern to Mitigate ²	Removal Efficiency Percentage ³

¹ Treatment Control BMPs must not be constructed within Receiving Waters. In addition, a proposed Treatment Control BMP may be listed more than once if they possess more than one qualifying pollutant removal efficiency.

² Cross Reference Table E.1 above to populate this column.

³ As documented in a Co-Permittee Approved Study and provided in Appendix 6.

Section F: Hydromodification

F.1 Hydrologic Conditions of Concern (HCOC) Analysis

Once you have determined that the LID design is adequate to address water quality requirements, you will need to assess if the proposed LID Design may still create a HCOC. Review Chapters 2 and 3 (including Figure 3-7) of the WQMP Guidance Document to determine if your project must mitigate for Hydromodification impacts. If your project meets one of the following criteria which will be indicated by the check boxes below, you do not need to address Hydromodification at this time. However, if the project does not qualify for Exemptions 1, 2 or 3, then additional measures must be added to the design to comply with HCOC criteria. This is discussed in further detail below in Section F.2.

HCOC EXEMPTION 1: The Priority Development Project disturbs less than one acre. The Copermitttee has the discretion to require a Project-Specific WQMP to address HCOCs on projects less than one acre on a case by case basis. The disturbed area calculation should include all disturbances associated with larger common plans of development.

Does the project qualify for this HCOC Exemption? Y N

If Yes, HCOC criteria do not apply.

HCOC EXEMPTION 2: The volume and time of concentration¹ of storm water runoff for the post-development condition is not significantly different from the pre-development condition for a 2-year return frequency storm (a difference of 5% or less is considered insignificant) using one of the following methods to calculate:

- Riverside County Hydrology Manual
- Technical Release 55 (TR-55): Urban Hydrology for Small Watersheds (NRCS 1986), or derivatives thereof, such as the Santa Barbara Urban Hydrograph Method
- Other methods acceptable to the Co-Permittee

Does the project qualify for this HCOC Exemption? Y N

If Yes, report results in Table F.1 below and provide your substantiated hydrologic analysis in Appendix 7.

Table F.1 Hydrologic Conditions of Concern Summary

	2 year – 24 hour		
	Pre-condition	Post-condition	% Difference
Flow (cubic feet per second)			
Volume (Cubic Feet)			

¹ Time of concentration is defined as the time after the beginning of the rainfall when all portions of the drainage basin are contributing to flow at the outlet.

HCOC EXEMPTION 3: All downstream conveyance channels to an adequate sump (for example, Prado Dam, Lake Elsinore, Canyon Lake, Santa Ana River, or other lake, reservoir or naturally erosion resistant feature) that will receive runoff from the project are engineered and regularly maintained to ensure design flow capacity; no sensitive stream habitat areas will be adversely affected; or are not identified on the Co-Permittees Hydromodification Susceptibility Maps.

Does the project qualify for this HCOC Exemption? Y N

If Yes, HCOC criteria do not apply and note below which adequate sump applies to this HCOC qualifier:

See receiving waters exhibit in Appendix 1 for downstream conveyance to Lake Elsinore.

See Appendix 7 for HCOC Exemption Map.

F.2 HCOC Mitigation

If none of the above HCOC Exemption Criteria are applicable, HCOC criteria is considered mitigated if they meet one of the following conditions:

- a. Additional LID BMPS are implemented onsite or offsite to mitigate potential erosion or habitat impacts as a result of HCOCs. This can be conducted by an evaluation of site-specific conditions utilizing accepted professional methodologies published by entities such as the California Stormwater Quality Association (CASQA), the Southern California Coastal Water Research Project (SCCRWP), or other Co-Permittee approved methodologies for site-specific HCOC analysis.
- b. The project is developed consistent with an approved Watershed Action Plan that addresses HCOC in Receiving Waters.
- c. Mimicking the pre-development hydrograph with the post-development hydrograph, for a 2-year return frequency storm. Generally, the hydrologic conditions of concern are not significant, if the post-development hydrograph is no more than 10% greater than pre-development hydrograph. In cases where excess volume cannot be infiltrated or captured and reused, discharge from the site must be limited to a flow rate no greater than 110% of the pre-development 2-year peak flow.
- d. None of the above

Be sure to include all pertinent documentation used in your analysis of the items a, b or c in Appendix 7.

Section G: Source Control BMPs

Source control BMPs include permanent, structural features that may be required in your project plans — such as roofs over and berms around trash and recycling areas — and Operational BMPs, such as regular sweeping and “housekeeping”, that must be implemented by the site’s occupant or user. The MEP standard typically requires both types of BMPs. In general, Operational BMPs cannot be substituted for a feasible and effective permanent BMP. Using the Pollutant Sources/Source Control Checklist in Appendix 8, review the following procedure to specify Source Control BMPs for your site:

1. **Identify Pollutant Sources:** Review Column 1 in the Pollutant Sources/Source Control Checklist. Check off the potential sources of Pollutants that apply to your site.
2. **Note Locations on Project-Specific WQMP Exhibit:** Note the corresponding requirements listed in Column 2 of the Pollutant Sources/Source Control Checklist. Show the location of each Pollutant source and each permanent Source Control BMP in your Project-Specific WQMP Exhibit located in Appendix 1.
3. **Prepare a Table and Narrative:** Check off the corresponding requirements listed in Column 3 in the Pollutant Sources/Source Control Checklist. In the left column of Table G.1 below, list each potential source of runoff Pollutants on your site (from those that you checked in the Pollutant Sources/Source Control Checklist). In the middle column, list the corresponding permanent, Structural Source Control BMPs (from Columns 2 and 3 of the Pollutant Sources/Source Control Checklist) used to prevent Pollutants from entering runoff. **Add additional narrative** in this column that explains any special features, materials or methods of construction that will be used to implement these permanent, Structural Source Control BMPs.
4. **Identify Operational Source Control BMPs:** To complete your table, refer once again to the Pollutant Sources/Source Control Checklist. List in the right column of your table the Operational BMPs that should be implemented as long as the anticipated activities continue at the site. Copermittee stormwater ordinances require that applicable Source Control BMPs be implemented; the same BMPs may also be required as a condition of a use permit or other revocable Discretionary Approval for use of the site.

Table G.1 Permanent and Operational Source Control Measures

Potential Sources of Runoff pollutants	Permanent Structural Source Control BMPs	Operational Source Control BMPs
On-site storm drain inlets	Mark all inlets with the words “Only Rain Down the Storm Drain” or similar. Catch Basin Markers may be available from the Riverside County Flood Control and Water Conservation District, call 951.955.1200 to verify.	Maintain and periodically repaint or replace inlet markings. Provide stormwater pollution prevention information to new site owners, lessees, or operators. See applicable operational BMPs in Fact Sheet SC-44, “Drainage System Maintenance,”
Landscape / Outdoor Pesticide Use	Design landscaping to minimize irrigation and runoff, to promote surface infiltration where appropriate, and to minimize the use of fertilizers and pesticides that can contribute to stormwater pollution. Where landscaped areas are used to retain or detain stormwater, specify plants that are tolerant of saturated soil conditions. Consider using pest-resistant plants, especially adjacent to hardscape. To ensure successful establishment, select plants appropriate to site soils, slopes, climate, sun, wind, rain, land use, air movement, ecological consistency, and plant interactions.	Maintain landscaping using minimum or no pesticides. See applicable operational BMPs in Appendix 10. Provide IPM information to new owners, lessees, and operators.
Roofing, gutters, and trim	Avoid roofing, gutters, and trim made of copper or other unprotected metals that may leach into runoff.	
Street Sweeping		See applicable operational BMPs in Appendix 10.

Section H: Construction Plan Checklist

Populate Table H.1 below to assist the plan checker in an expeditious review of your project. The first two columns will contain information that was prepared in previous steps, while the last column will be populated with the corresponding plan sheets. This table is to be completed with the submittal of your final Project-Specific WQMP.

Table 0.1 Construction Plan Cross-reference

BMP No. or ID	BMP Identifier and Description	Corresponding Plan Sheet(s)	BMP Location (Lat/Long)
BIO1	Bio-Retention basin	TTM 38237	33.914045,-117.182536
BIO2	Bio-Retention basin	TTM 38237	33.914164,-117.180782

Note that the updated table — or Construction Plan WQMP Checklist — is **only a reference tool** to facilitate an easy comparison of the construction plans to your Project-Specific WQMP. Co-Permittee staff can advise you regarding the process required to propose changes to the approved Project-Specific WQMP.

Section I: Operation, Maintenance and Funding

The Copermittee will periodically verify that Stormwater BMPs on your site are maintained and continue to operate as designed. To make this possible, your Copermittee will require that you include in Appendix 9 of this Project-Specific WQMP:

1. A means to finance and implement facility maintenance in perpetuity, including replacement cost.
2. Acceptance of responsibility for maintenance from the time the BMPs are constructed until responsibility for operation and maintenance is legally transferred. A warranty covering a period following construction may also be required.
3. An outline of general maintenance requirements for the Stormwater BMPs you have selected.
4. Figures delineating and designating pervious and impervious areas, location, and type of Stormwater BMP, and tables of pervious and impervious areas served by each facility. Geo-locating the BMPs using a coordinate system of latitude and longitude is recommended to help facilitate a future statewide database system.
5. A separate list and location of self-retaining areas or areas addressed by LID Principles that do not require specialized O&M or inspections but will require typical landscape maintenance as noted in Chapter 5, pages 85-86, in the WQMP Guidance. Include a brief description of typical landscape maintenance for these areas.

Your local Co-Permittee will also require that you prepare and submit a detailed Stormwater BMP Operation and Maintenance Plan that sets forth a maintenance schedule for each of the Stormwater BMPs built on your site. An agreement assigning responsibility for maintenance and providing for inspections and certification may also be required.

Details of these requirements and instructions for preparing a Stormwater BMP Operation and Maintenance Plan are in Chapter 5 of the WQMP Guidance Document.

Maintenance Mechanism: HOA

Will the proposed BMPs be maintained by a Home Owners' Association (HOA) or Property Owners Association (POA)?

Y N

Include your Operation and Maintenance Plan and Maintenance Mechanism in Appendix 9. Additionally, include all pertinent forms of educational materials for those personnel that will be maintaining the proposed BMPs within this Project-Specific WQMP in Appendix 10.

Appendix 1: Maps and Site Plans

Location Map, WQMP Site Plan and Receiving Waters Map

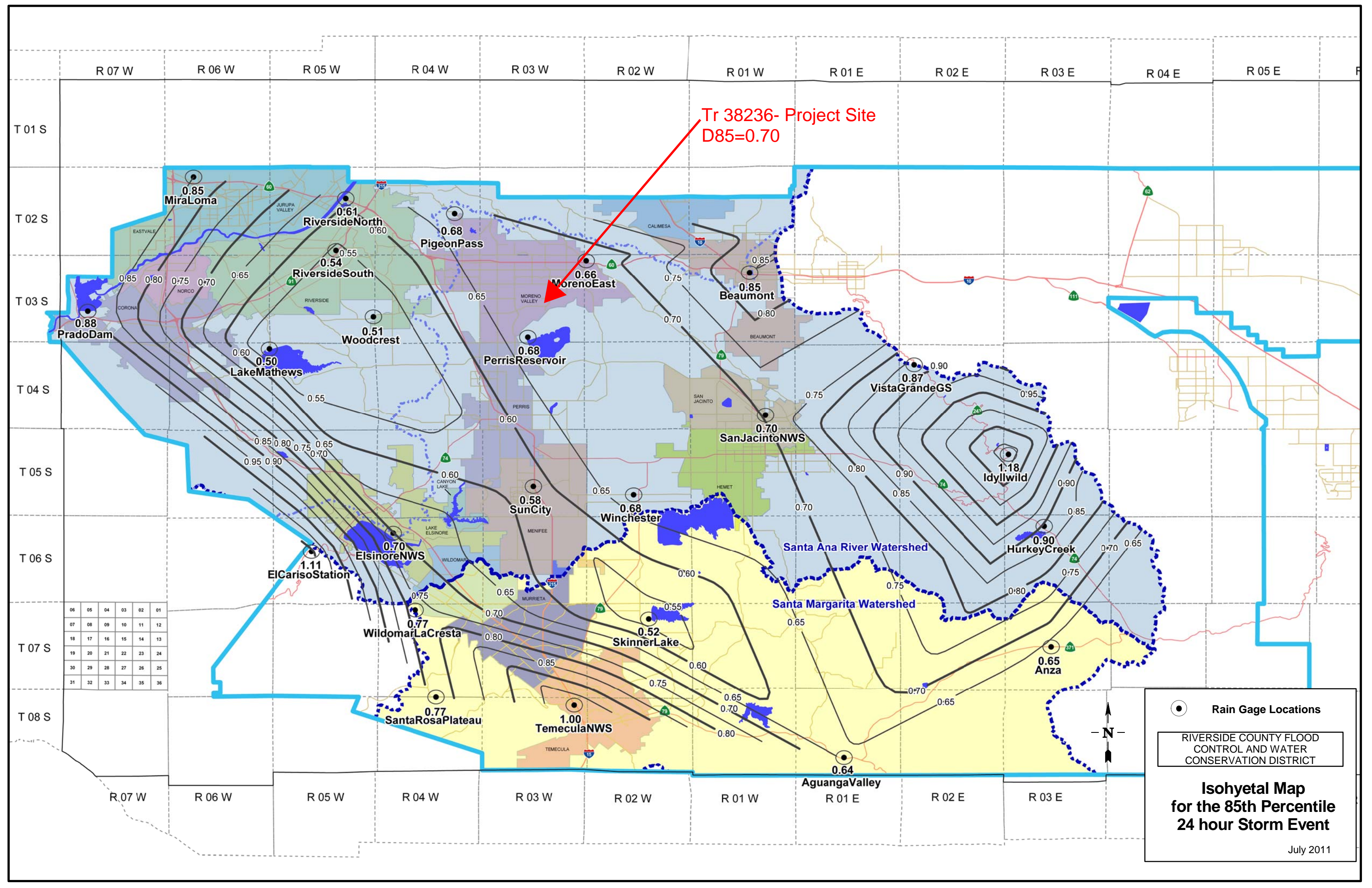

Tr 38236- Project Site
D85=0.70

06	05	04	03	02	01
07	08	09	10	11	12
18	17	16	15	14	13
19	20	21	22	23	24
30	29	28	27	26	25
31	32	33	34	35	36

● Rain Gage Locations

RIVERSIDE COUNTY FLOOD CONTROL AND WATER CONSERVATION DISTRICT

Isohyetal Map for the 85th Percentile 24 hour Storm Event

July 2011

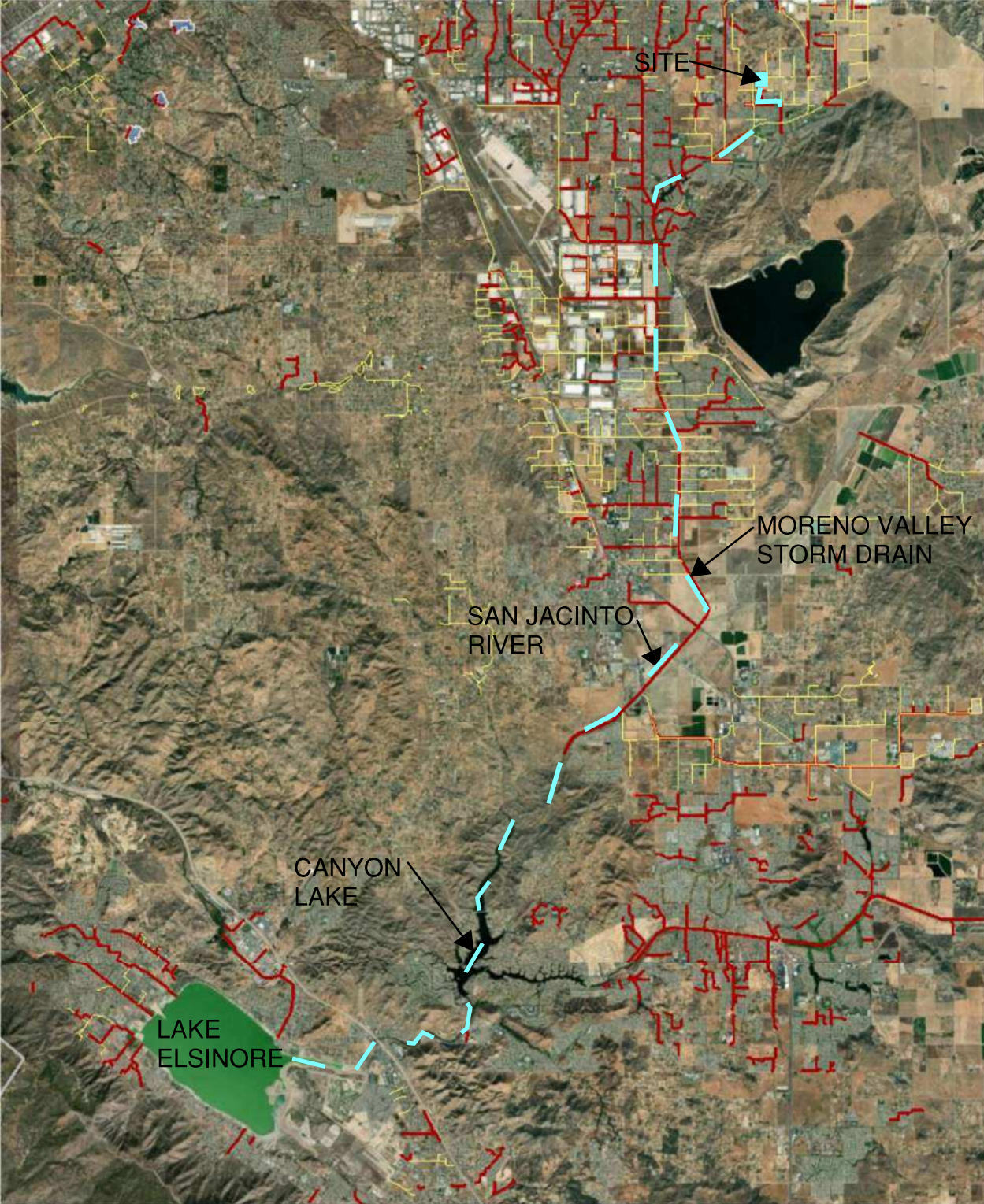

BMP MAP

TRACT 38237

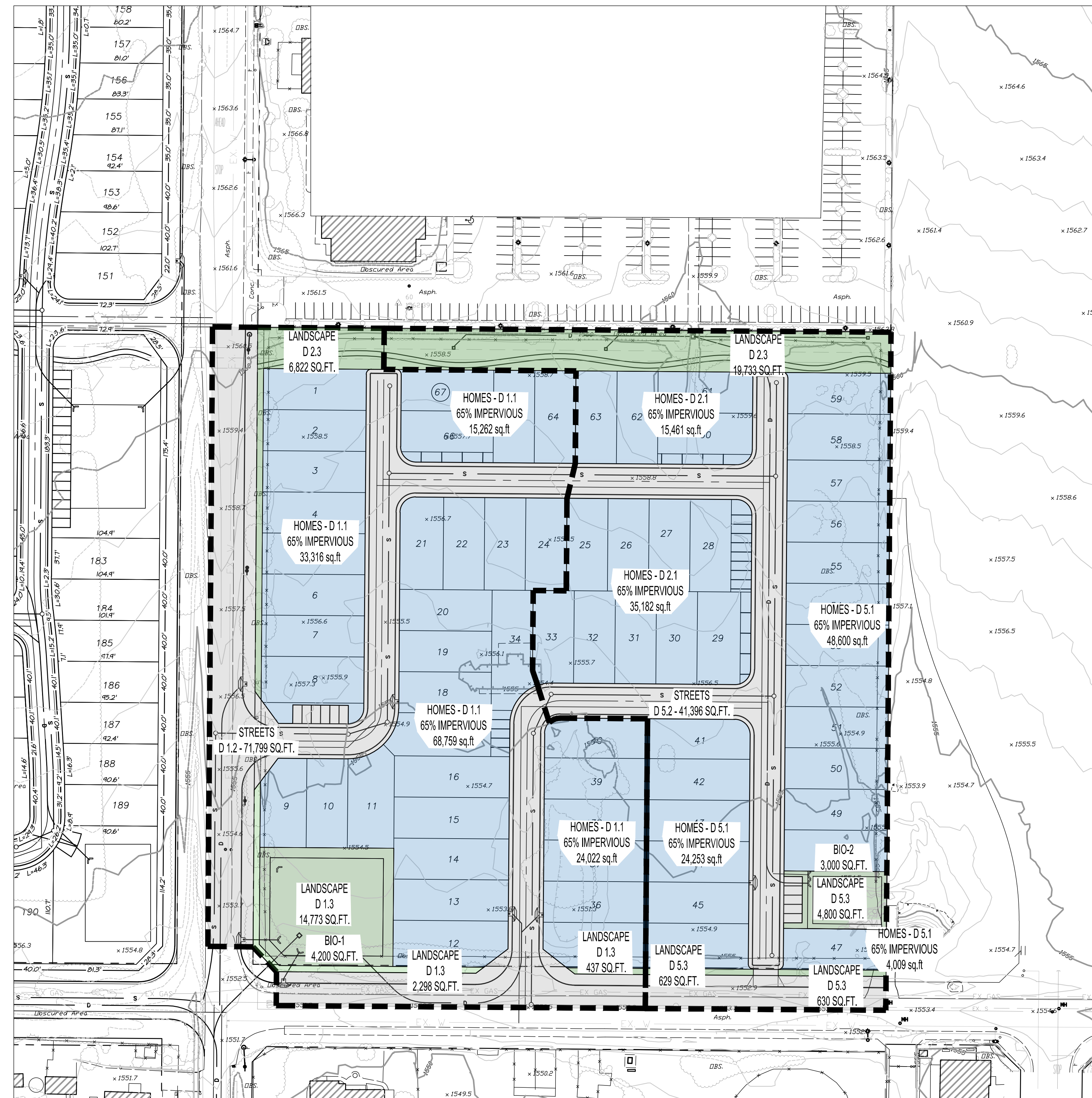

DMA 1				
DMA	DMA CLASSIFICATION	NAME	SURFACE TYPE	AREA (SF)
1.1	D	HOMES	ROOF/LANDSCAPE 50% IMPERVIOUS	141,354
1.2	D	STREETS	ASPHALT/CONCRETE	71,799
1.3	D	LANDSCAPING	ORNAMENTAL LANDSCAPING	24,330
TOTAL				237,483

DMA 2				
DMA	DMA CLASSIFICATION	NAME	SURFACE TYPE	AREA (SF)
2.1	D	HOMES	ROOF/LANDSCAPE 50% IMPERVIOUS	127,505
2.2	D	STREETS	ASPHALT/CONCRETE	41,396
2.3	D	LANDSCAPING	ORNAMENTAL LANDSCAPING	25,792
TOTAL				194,693

LEGEND

AREA	ACRES
LENGTH	SOIL

NODE	Q10=	cfs
ELEV	Q100=	cfs
	Tc=	min
	ACRES=	

--- DRAINAGE AREA BOUNDARY

--- FLOW PATH

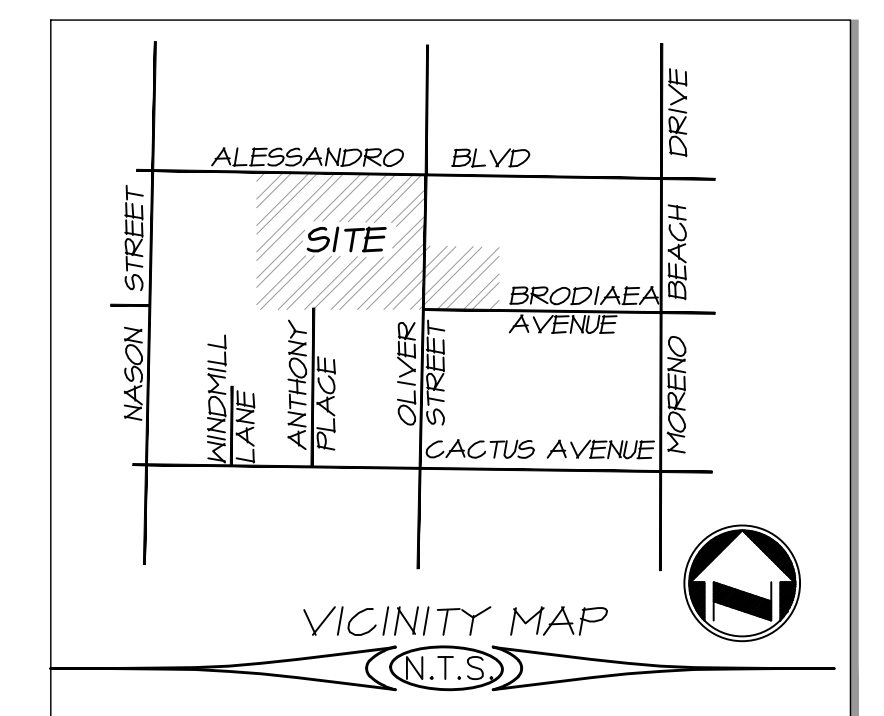
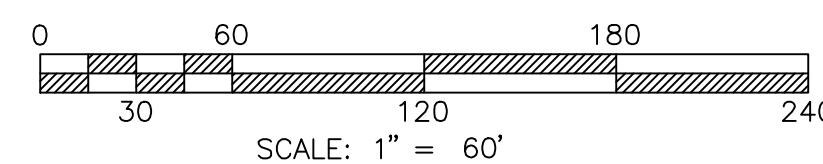

BMP MAP
TRACT 38237
PREPARATION DATE : AUGUST 2021
PLAN PREPARED BY:
adkan ENGINEERS
Civil Engineering • Surveying • Planning
6879 Airport Drive, Riverside, CA 92504
Tel:(951) 688-0241 Fax:(951) 688-0599

Appendix 2: Construction Plans

Grading and Drainage Plans

IN THE CITY OF MORENO VALLEY, COUNTY OF RIVERSIDE, STATE OF CALIFORNIA
TENTATIVE TRACT MAP 38231

DR HORTON

JULY 2021

OWNER
DISCOVERY CHRISTIAN CHURCH OF MORENO VALLEY
21555 ALESSANDRO AVE
MORENO VALLEY, CA 92555
PH: (951) 424-3002

ENGINEER
adkan ENGINEERS
6878 AIRPORT DRIVE
RIVERSIDE, CA 92504
951-688-0241

UTILITY PURVEYORS
WATER: EASTERN MUNICIPAL WATER DISTRICT
SEWER: EASTERN MUNICIPAL WATER DISTRICT
GAS: SOUTHERN CALIFORNIA GAS COMPANY
ELECTRICITY: CITY OF MORENO VALLEY
TELEPHONE: VERIZON
CATV: ADELPHIA

- PROJECT NOTES**
- THE EXISTENCE AND LOCATION OF ANY UNDERGROUND UTILITY PIPES OR STRUCTURES SHOWN ON THESE PLANS WERE OBTAINED BY A SEARCH OF THE AVAILABLE RECORDS. TO THE BEST OF OUR KNOWLEDGE, THERE ARE NO EXISTING UTILITIES EXCEPT AS SHOWN ON THIS PLAN. THE CONTRACTOR IS REQUIRED TO TAKE DUE PRECAUTIONARY MEASURES TO PROTECT THE UTILITY LINES SHOWN AND ANY OTHER LINES NOT OF RECORD OR NOT SHOWN ON THIS DRAWING.
 - CONSTRUCTION CONTRACTOR AGREES THAT IN ACCORDANCE WITH GENERALLY ACCEPTED CONSTRUCTION PRACTICES, HE/SHE WILL BE REQUIRED TO ASSUME SOLE AND COMPLETE RESPONSIBILITY FOR JOB SITE CONDITIONS DURING THE COURSE OF CONSTRUCTION OF THE PROJECT, INCLUDING SAFETY OF ALL PERSONS AND PROPERTY; THAT THIS REQUIREMENT SHALL BE MADE TO APPLY CONTINUOUSLY AND NOT BE LIMITED TO NORMAL WORKING HOURS, AND CONSTRUCTION CONTRACTOR FURTHER AGREES TO DEFEND, INDEMNIFY AND HOLD DESIGN PROFESSIONAL HARMLESS FROM ANY AND ALL LIABILITY, REAL OR ALLEGED, IN CONNECTION WITH THE PERFORMANCE OF WORK ON THIS PROJECT, EXCEPTING LIABILITY ARISING FROM THE SOLE NEGLIGENCE OF DESIGN PROFESSIONAL.
 - 2010 THOMAS EGGS, MAP BOOK, PAGE 710, GRID C-6
 - SITE IS LOCATED IN LOW/MODERATE LIQUEFACTION AREA AND IS SUSCEPTIBLE TO SUBSIDENCE.
 - LAND IS NOT SUBJECT TO OVERFLOW INUNDATION OR FLOOD HAZARD
 - PROJECT IS LOCATED IN A HIGH FIRE AREA.
 - ALL IMPROVEMENTS SHALL BE PER SCHEDULE "A" SUBDIVISION ORDINANCE 460.
 - NO SUBSURFACE SEPTIC BEHAUSE DISP #2560SAL IS INTENDED.
 - THIS MAP DOES NOT INCLUDE THE ENTIRE CONTIGUOUS OWNERSHIP OF THE LAND DIVIDER.
 - THIS PROJECT IS LOCATED WITHIN THE TEMESCAL CSA #34 - STREET LIGHTING.
 - FLOOD ZONE X AREA OF MINIMAL FLOODING PER FEMA PANEL 60652C0096.
 - NO KNOWN EXISTING WELLS ON OR AROUND THE PROPERTY.
 - PROJECT IS LOCATED WITHIN THE RIVERSIDE COUNTY FAULT HAZARD MANAGEMENT ZONE FOR A MAPPED TRACE OF THE GLEN IVY SOUTH FAULT. SITE IS LOCATED IN A HIGH SENSITIVITY PALEONTOLOGICAL AREA.
 - SITE IS LOCATED WITHIN THE CORONA-NORCO SCHOOL DISTRICT.

ASSESSORS PARCEL NUMBER
486-240-010

LEGEND

PROP DOMESTIC WATER	— W —
PROPOSED SEWER	— S —
TRACT BOUNDARY	— — — — —
OLD TRACT BOUNDARY	- - - - -
PHASING BOUNDARY	— — — — —
A.D.A ACCESS RAMP	— — — — —
PROPOSED BLOCK WALL	— — — — —
FAULT SETBACK LINE	— — — — —

SD = STORM DRAIN
TG = TOP OF CURB
FS = FINISH SURFACE
SHR = SEWER
CL = CENTER LINE
FS = FINISHED GROUND
WTR = WATER
PL = PROPERTY LINE
R/L = RIGHT OF WAY
A.R. = A.D.A ACCESS RAMP

SN = SIDEWALK
() = EXISTING ELEVATION
C/G = CURB AND GUTTER
S.F. = SQUARE FEET
FS = FINISH SURFACE
FH = FIRE HYDRANT
TH = TOP OF HALL
TF = TOP OF FOOTING
FL = FLOW LINE
T.B.R. = TO BE REMOVED

EARTHWORK QUANTITIES

CUT - CY	FILL - CY	IMPORT - CY
----------	-----------	-------------

THE QUANTITY SHOWN ABOVE IS FOR DISCUSSION PURPOSES ONLY.

TENTATIVE TRACT SUMMARY

TOTAL AREA GROSS: 8.8 ACRES
EXISTING ZONING: R-5
PROPOSED ZONING: RS-10
EXISTING LAND USE: SUBURBAN RESIDENTIAL
PROPOSED LAND USE: SUBURBAN RESIDENTIAL
EXISTING SURROUNDING LAND USE: RESIDENTIAL AGRICULTURE 2, SUBURBAN RESIDENTIAL
EXISTING SURROUNDING ZONING: RA-2, R-3, R-5

BENCHMARK

1/4" 52 BRASS DISK AT THE NW CORNER OF ALESSANDRO BLVD. AND REDLANDS BLVD. 170.0 FEET NORTH OF ALESSANDRO BLVD.; 43.0 FEET WEST OF REDLANDS BLVD.; 2.0 FEET SE OF POWER POLE #21559 C.W.T.; 1.0 FEET NORTH OF A MARKER POST, A BRASS DISK SET IN THE TOP OF A CONCRETE POST AND MARKED "1/4" 52 1993" ELEVATION: 1603.71 NAVD 1988

BASIS OF BEARINGS

THE BASIS OF BEARINGS FOR THIS SURVEY IS THE CALIFORNIA STATE PLANE COORDINATE SYSTEM, CCS83, ZONE 6, BASED LOCALLY ON CONTROL STATIONS "P482", "P478", AND "SBCO" NAD 83 (NAD83/2011) EPOCH 2010.00 AS SHOWN HEREON. ALL BEARINGS SHOWN ON THIS MAP ARE GRID, QUOTED BEARINGS AND DISTANCES FROM REFERENCE MAPS OR DEEDS ARE AS SHOWN PER THAT RECORD REFERENCE. ALL DISTANCES SHOWN ARE GROUND DISTANCES UNLESS SPECIFIED OTHERWISE. GRID DISTANCES MAY BE OBTAINED BY MULTIPLYING THE GROUND DISTANCE BY A COMBINATION FACTOR OF 0.9993379. CALCULATIONS ARE MADE AT 11P TAGGED "LS 5174" DOWN 0.2" IN WELL PER TRACT 36882, MB 454/37-39 WITH COORDINATES OF: N: 2277362.55000000, E: 6280631.21000000 USING AN ELEVATION OF 1565.533.

TOPOGRAPHY SOURCE

TOPOGRAPHY COMPILED PHOTOGRAMMETRICALLY BY INLAND AERIAL SURVEY INC. ON 05-14-20 AND 03-26-21

PROJECT DENSITY TABLE

LOT	RESIDENTIAL		NON-RESIDENTIAL	
	NET AREA	PAD AREA	LOT	NET AREA
1	16,741 S.F.	6,576 S.F.	A	2.52 AC.
2	15,633 S.F.	6,524 S.F.	B	0.78 AC.
3	13,124 S.F.	7,085 S.F.	C	0.18 AC.
4	23,136 S.F.	6,767 S.F.		
5	22,338 S.F.	10,286 S.F.		
6	13,920 S.F.	10,484 S.F.		
7	13,587 S.F.	8,254 S.F.		
8	19,042 S.F.	13,472 S.F.		
9	10,043 S.F.	5,063 S.F.		
10	9,428 S.F.	6,342 S.F.		
11	9,347 S.F.	6,181 S.F.		
12	9,258 S.F.	5,969 S.F.		
13	7,731 S.F.	5,209 S.F.		
14	8,117 S.F.	6,046 S.F.		
15	8,109 S.F.	5,122 S.F.		

AVG. LOT SIZE = 13,305 S.F.
SUBDIVISION DENSITY = 0.44 DU/ACRE

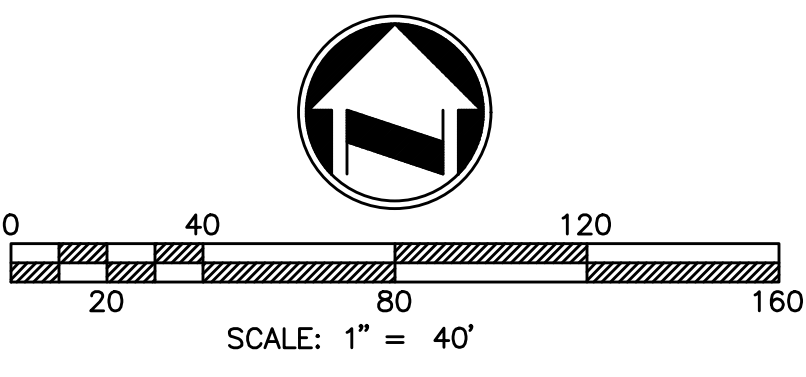
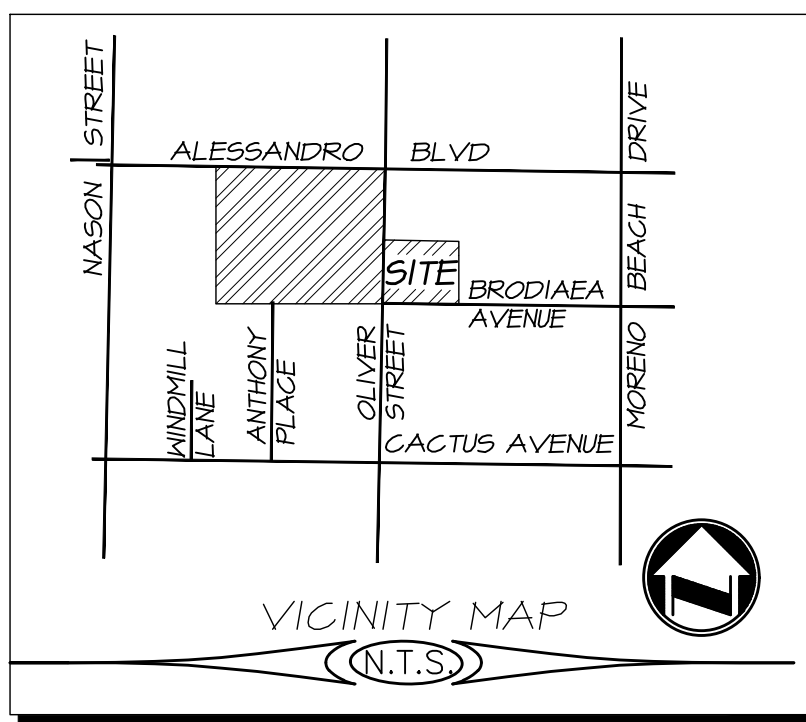
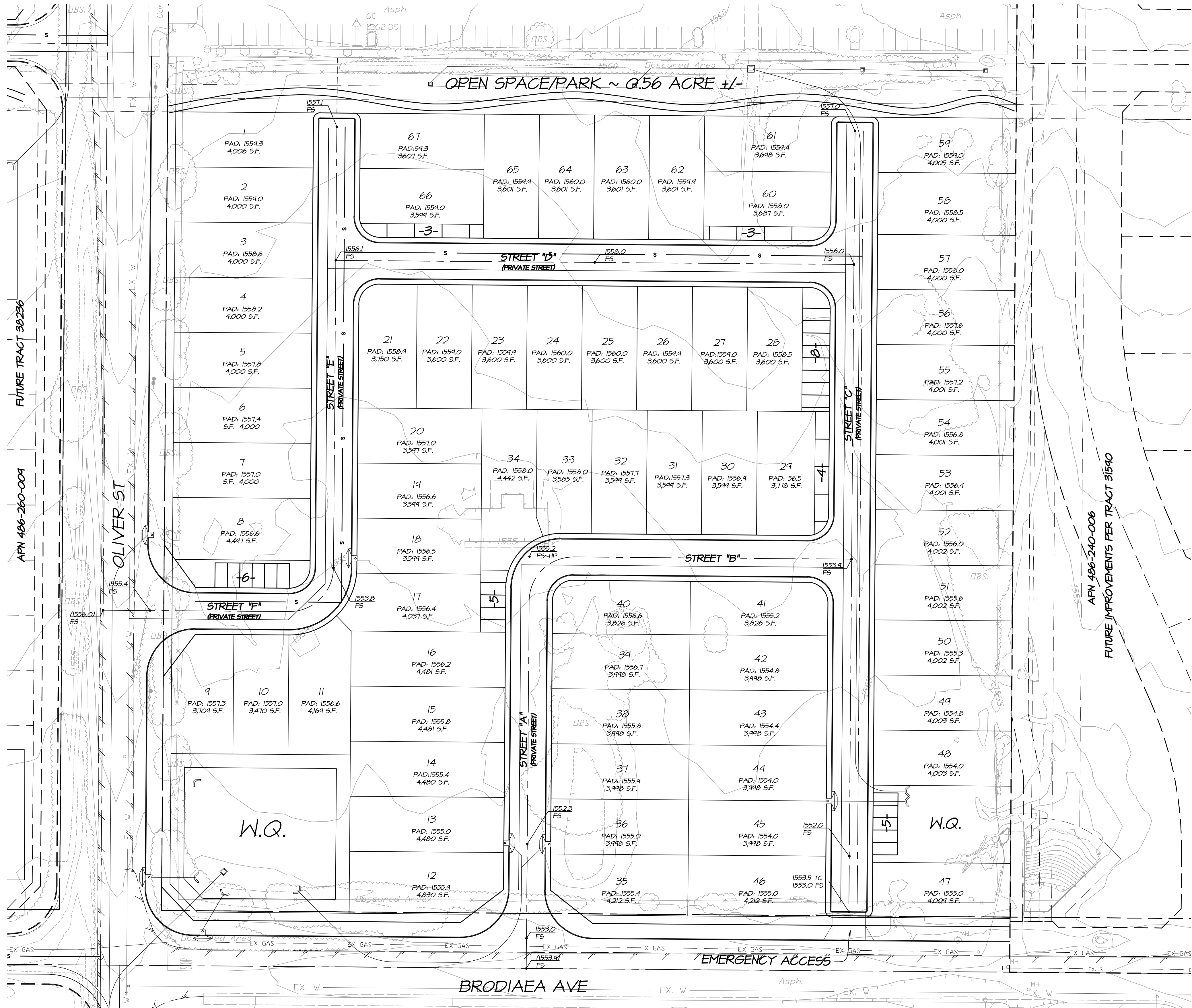

2800 S.F. DESIGN STANDARDS

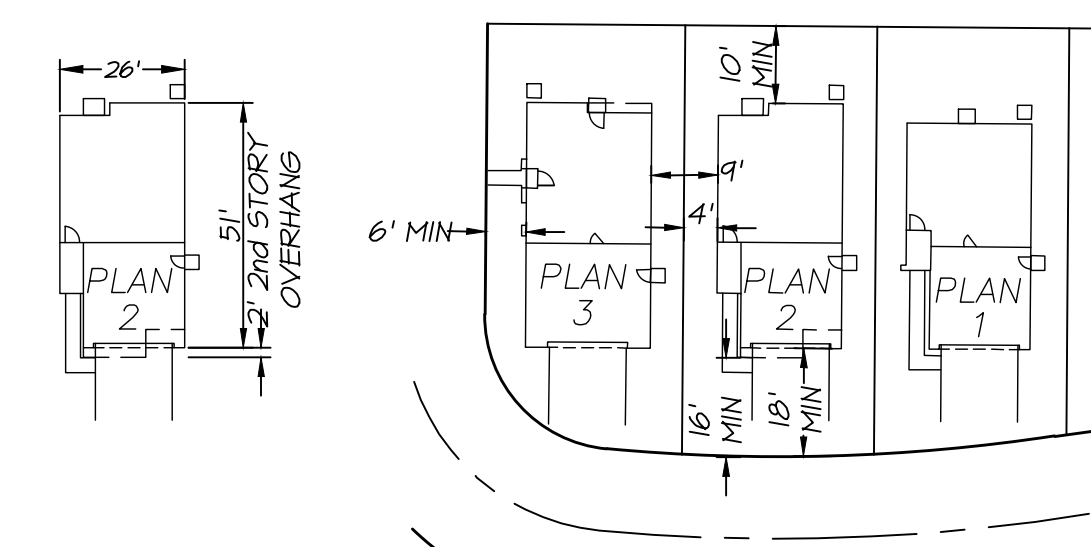

APPROXIMATE HOUSE SIZE

SETBACKS

2800 S.F. SETBACKS
FRONT YARD: 10' FIRST STORY
16' SECOND STORY
SIDE YARD: 4' MINIMUM
REAR YARD: 10' MINIMUM
CORNER LOT SIDE ENTRY: 6' MINIMUM

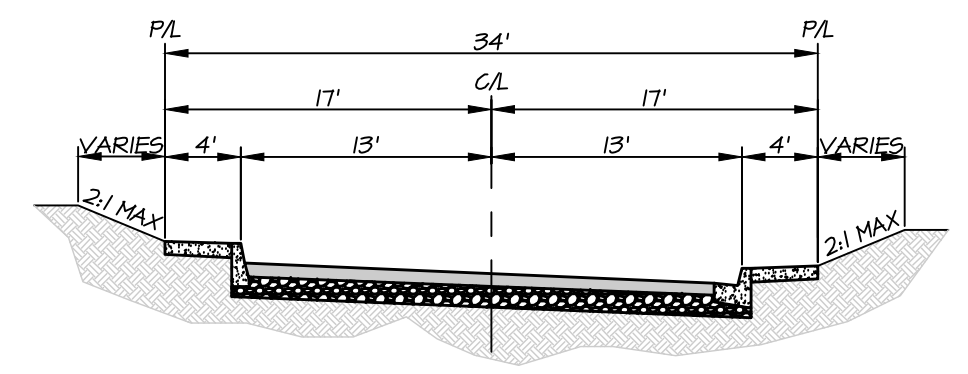

SECTION A-A TYPICAL SECTION PRIVATE STREET SCALE: 1" = 10'

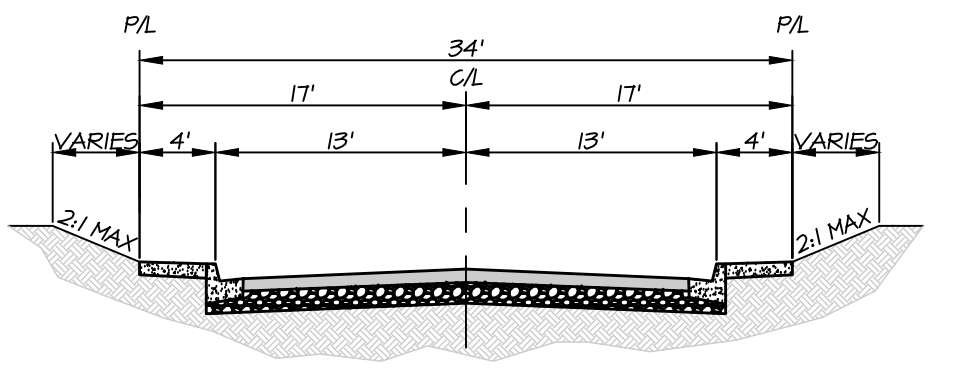

SECTION B-B TYPICAL SECTION PRIVATE STREET SCALE: 1" = 10'

Appendix 3: Soils Information

Geotechnical Study and Other Infiltration Testing Data

Appendix 4: Historical Site Conditions

Phase I Environmental Site Assessment or Other Information on Past Site Use

“Not Applicable”

Appendix 5: LID Infeasibility

LID Technical Infeasibility Analysis

“Not Applicable”

Appendix 6: BMP Design Details

BMP Sizing, Design Details and other Supporting Documentation

Santa Ana Watershed - BMP Design Volume, V_{BMP}

(Rev. 10-2011)

Legend: Required Entries
 Calculated Cells

*(Note this worksheet shall **only** be used in conjunction with BMP designs from the **LID BMP Design Handbook**)*

Company Name **ADKAN ENGINEERS** Date **8-12-21'**
 Designed by **Jose Contreras** Case No
 Company Project Number/Name

BMP Identification

BMP NAME / ID **Bio-Retention Basin 1 - Tract 38237**
Must match Name/ID used on BMP Design Calculation Sheet

Design Rainfall Depth

85th Percentile, 24-hour Rainfall Depth, D_{85} = **0.70** inches
 from the Isohyetal Map in Handbook Appendix E

Drainage Management Area Tabulation

Insert additional rows if needed to accommodate all DMAs draining to the BMP

DMA Type/ID	DMA Area (square feet)	Post-Project Surface Type	Effective Imperivous Fraction, I_f	DMA Runoff Factor	DMA Areas x Runoff Factor	Design Storm Depth (in)	Design Capture Volume, V_{BMP} (cubic feet)	Proposed Volume on Plans (cubic feet)
D.1.1	141,359.00	Mixed Surface Types	0.5	0.34	47956			
D.1.2	71,799.00	Concrete or Asphalt	1	0.89	64044.7			
D.1.3	24,330	Ornamental Landscaping	0.1	0.11	2687.4			
237488		Total			114688.1	0.70	6690.1	6690.1

Notes:

Bioretention Facility - Design Procedure		BMP ID BIO1 TR38237	Legend:	Required Entries	
				Calculated Cells	
Company Name:	ADKAN ENGINEERS		Date:	8-12-21'	
Designed by:	JOSE CONTRERAS		County/City Case No.:		
Design Volume					
Enter the area tributary to this feature			$A_T =$	5.45	acres
Enter V_{BMP} determined from Section 2.1 of this Handbook			$V_{BMP} =$	6,690	ft ³
Type of Bioretention Facility Design					
<input checked="" type="radio"/> Side slopes required (parallel to parking spaces or adjacent to walkways) <input type="radio"/> No side slopes required (perpendicular to parking space or Planter Boxes)					
Bioretention Facility Surface Area					
Depth of Soil Filter Media Layer			$d_S =$	2.5	ft
Top Width of Bioretention Facility, excluding curb			$w_T =$	35.0	ft
Total Effective Depth, d_E $d_E = (0.3) \times d_S + (0.4) \times 1 - (0.7/w_T) + 0.5$			$d_E =$	1.63	ft
Minimum Surface Area, A_m $A_M (ft^2) = \frac{V_{BMP} (ft^3)}{d_E (ft)}$			$A_M =$	4,105	ft ²
Proposed Surface Area			$A =$	4,200	ft ²
Bioretention Facility Properties					
Side Slopes in Bioretention Facility			$z =$	4	:1
Diameter of Underdrain				6	inches
Longitudinal Slope of Site (3% maximum)				0	%
6" Check Dam Spacing				0	feet
Describe Vegetation:			Natural Grasses		
Notes:					

Santa Ana Watershed - BMP Design Volume, V_{BMP}

(Rev. 10-2011)

Legend: Required Entries
 Calculated Cells

*(Note this worksheet shall **only** be used in conjunction with BMP designs from the **LID BMP Design Handbook**)*

Company Name **ADKAN ENGINEERS** Date **8-12-21'**
 Designed by **Jose Contreras** Case No
 Company Project Number/Name

BMP Identification

BMP NAME / ID **Bio-Retention Basin 2 - Tract 38237**
Must match Name/ID used on BMP Design Calculation Sheet

Design Rainfall Depth

85th Percentile, 24-hour Rainfall Depth, D_{85} = **0.70** inches
 from the Isohyetal Map in Handbook Appendix E

Drainage Management Area Tabulation

Insert additional rows if needed to accommodate all DMAs draining to the BMP

DMA Type/ID	DMA Area (square feet)	Post-Project Surface Type	Effective Imperivous Fraction, I_f	DMA Runoff Factor	DMA Areas x Runoff Factor	Design Storm Depth (in)	Design Capture Volume, V_{BMP} (cubic feet)	Proposed Volume on Plans (cubic feet)
D.2.1	127,505.00	Mixed Surface Types	0.5	0.34	43256.1			
D.2.2	41,396.00	Concrete or Asphalt	1	0.89	36925.2			
D.2.3	25,792	Ornamental Landscaping	0.1	0.11	2848.9			
194693		Total			83030.2			

Notes:

Bioretention Facility - Design Procedure		BMP ID BIO2 TR38237	Legend:	Required Entries	
				Calculated Cells	
Company Name:	ADKAN ENGINEERS		Date:	8-12-21'	
Designed by:	JOSE CONTRERAS		County/City Case No.:		
Design Volume					
Enter the area tributary to this feature			$A_T =$	4.47	acres
Enter V_{BMP} determined from Section 2.1 of this Handbook			$V_{BMP} =$	4,843	ft ³
Type of Bioretention Facility Design					
<input type="radio"/> Side slopes required (parallel to parking spaces or adjacent to walkways) <input checked="" type="radio"/> No side slopes required (perpendicular to parking space or Planter Boxes)					
Bioretention Facility Surface Area					
Depth of Soil Filter Media Layer			$d_S =$	2.5	ft
Top Width of Bioretention Facility, excluding curb			$w_T =$	77.0	ft
Total Effective Depth, d_E					
$d_E = [(0.3) \times d_S + (0.4) \times 1] + 0.5$			$d_E =$	1.65	ft
Minimum Surface Area, A_m					
$A_M (ft^2) = \frac{V_{BMP} (ft^3)}{d_E (ft)}$			$A_M =$	2,936	ft ²
Proposed Surface Area			$A =$	3,000	ft ²
Minimum Required Length of Bioretention Facility, L			$L =$	38.1	ft
Bioretention Facility Properties					
Side Slopes in Bioretention Facility			$z =$	1	:1
Diameter of Underdrain				6	inches
Longitudinal Slope of Site (3% maximum)				0	%
6" Check Dam Spacing				0	feet
Describe Vegetation:			Natural Grasses		
Notes:					

Appendix 7: Hydromodification

Supporting Detail Relating to Hydrologic Conditions of Concern



Riverside County SWCT² Stormwater & Water Conservation Tracking Tool

TOC Choose search item from list Enter Value Locate Clear



- Clear All Metadata
- ▶ Base Maps
- ▶ Base Data
- ▶ Stormwater Data
 - Hydromodification Susceptibility Mapping
 - 2010 - 303d/TMDL
 - Hydromodification Exemption Areas
 - Potentially Not Exempt
 - Potentially Exempt
 - District Facilities
 - District Facilities
 - Proposed District Facilities
 - Basin
 - Detention Basin
 - Retention Basin
 - Debris Basin
 - Dam
 - Levee
 - Spreading Grounds
 - Other
 - Permit Areas
 - Hydrologic Unit Codes (HUC)
 - Topographic Drainage Boundary
 - Drainage Area Boundaries
 - City Storm Drains
 - WQMP 85% Design Isohyetal Map
 - CRP (Control Release Point)
 - FEMA Flood Plain
 - Flood Plain - Other Special Studies
 - As-Built Plans
- ▶ Groundwater Data
- ▶ U.S. Fish and Wildlife Critical Habitat
- ▶ WRMSHCP Potential Survey Areas
- ▶ SKRHCP
- ▶ CVMSHCP Survey Data and Conservation Areas

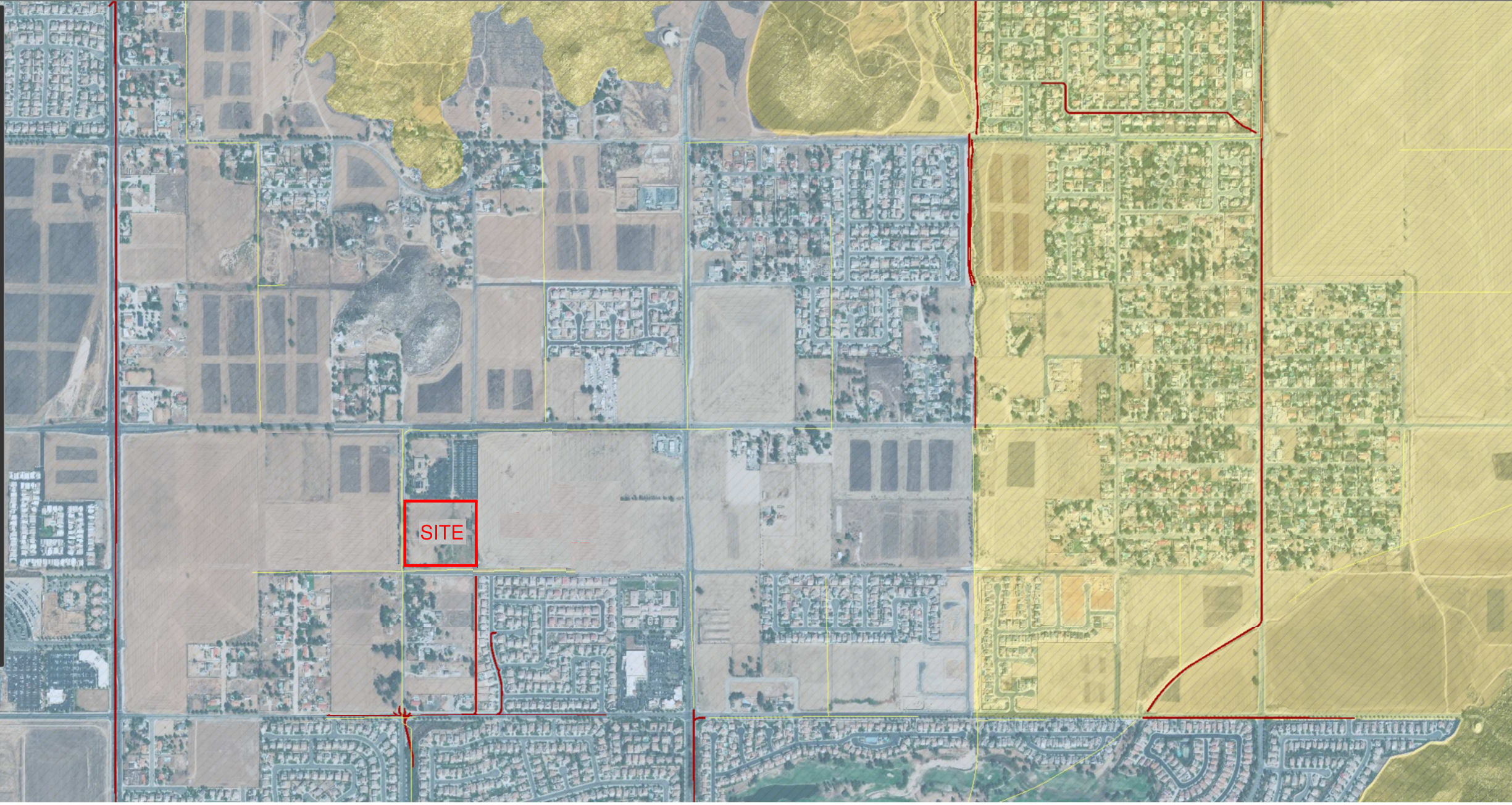

Appendix 8: Source Control

Pollutant Sources/Source Control Checklist

STORMWATER POLLUTANT SOURCES/SOURCE CONTROL CHECKLIST

How to use this worksheet (also see instructions in Section G of the WQMP Template):

1. Review Column 1 and identify which of these potential sources of stormwater pollutants apply to your site. Check each box that applies.
2. Review Column 2 and incorporate all of the corresponding applicable BMPs in your WQMP Exhibit.
3. Review Columns 3 and 4 and incorporate all of the corresponding applicable permanent controls and operational BMPs in your WQMP. Use the format shown in Table G.1 on page 23 of this WQMP Template. Describe your specific BMPs in an accompanying narrative, and explain any special conditions or situations that required omitting BMPs or substituting alternative BMPs for those shown here.

IF THESE SOURCES WILL BE ON THE PROJECT SITE THEN YOUR WQMP SHOULD INCLUDE THESE SOURCE CONTROL BMPs, AS APPLICABLE		
1 Potential Sources of Runoff Pollutants	2 Permanent Controls—Show on WQMP Drawings	3 Permanent Controls—List in WQMP Table and Narrative	4 Operational BMPs—Include in WQMP Table and Narrative
<input checked="" type="checkbox"/> A. On-site storm drain inlets	<input checked="" type="checkbox"/> Locations of inlets.	<input checked="" type="checkbox"/> Mark all inlets with the words “Only Rain Down the Storm Drain” or similar. Catch Basin Markers may be available from the Riverside County Flood Control and Water Conservation District, call 951.955.1200 to verify.	<input checked="" type="checkbox"/> Maintain and periodically repaint or replace inlet markings. <input checked="" type="checkbox"/> Provide stormwater pollution prevention information to new site owners, lessees, or operators. <input checked="" type="checkbox"/> See applicable operational BMPs in Fact Sheet SC-44, “Drainage System Maintenance,” in the CASQA Stormwater Quality Handbooks at www.cabmphandbooks.com <input checked="" type="checkbox"/> Include the following in lease agreements: “Tenant shall not allow anyone to discharge anything to storm drains or to store or deposit materials so as to create a potential discharge to storm drains.”
<input type="checkbox"/> B. Interior floor drains and elevator shaft sump pumps		<input type="checkbox"/> State that interior floor drains and elevator shaft sump pumps will be plumbed to sanitary sewer.	<input type="checkbox"/> Inspect and maintain drains to prevent blockages and overflow.
<input type="checkbox"/> C. Interior parking garages		<input type="checkbox"/> State that parking garage floor drains will be plumbed to the sanitary sewer.	<input type="checkbox"/> Inspect and maintain drains to prevent blockages and overflow.

STORMWATER POLLUTANT SOURCES/SOURCE CONTROL CHECKLIST

IF THESE SOURCES WILL BE ON THE PROJECT SITE THEN YOUR WQMP SHOULD INCLUDE THESE SOURCE CONTROL BMPs, AS APPLICABLE		
1 Potential Sources of Runoff Pollutants	2 Permanent Controls—Show on WQMP Drawings	3 Permanent Controls—List in WQMP Table and Narrative	4 Operational BMPs—Include in WQMP Table and Narrative
<input type="checkbox"/> D1. Need for future indoor & structural pest control		<input type="checkbox"/> Note building design features that discourage entry of pests.	<input type="checkbox"/> Provide Integrated Pest Management information to owners, lessees, and operators.
<input checked="" type="checkbox"/> D2. Landscape/ Outdoor Pesticide Use	<input type="checkbox"/> Show locations of native trees or areas of shrubs and ground cover to be undisturbed and retained. <input checked="" type="checkbox"/> Show self-retaining landscape areas, if any. <input type="checkbox"/> Show stormwater treatment and hydrograph modification management BMPs. (See instructions in Chapter 3, Step 5 and guidance in Chapter 5.)	<p>State that final landscape plans will accomplish all of the following.</p> <input type="checkbox"/> Preserve existing native trees, shrubs, and ground cover to the maximum extent possible. <input checked="" type="checkbox"/> Design landscaping to minimize irrigation and runoff, to promote surface infiltration where appropriate, and to minimize the use of fertilizers and pesticides that can contribute to stormwater pollution. <input type="checkbox"/> Where landscaped areas are used to retain or detain stormwater, specify plants that are tolerant of saturated soil conditions. <input checked="" type="checkbox"/> Consider using pest-resistant plants, especially adjacent to hardscape. <p>To insure successful establishment, select plants appropriate to site soils, slopes, climate, sun, wind, rain, land use, air movement, ecological consistency, and plant interactions.</p>	<input checked="" type="checkbox"/> Maintain landscaping using minimum or no pesticides. <input checked="" type="checkbox"/> See applicable operational BMPs in “What you should know for.....Landscape and Gardening” at http://rcflood.org/stormwater/Error! <small>Hyperlink reference not valid.</small> <input checked="" type="checkbox"/> Provide IPM information to new owners, lessees and operators.

STORMWATER POLLUTANT SOURCES/SOURCE CONTROL CHECKLIST

IF THESE SOURCES WILL BE ON THE PROJECT SITE THEN YOUR WQMP SHOULD INCLUDE THESE SOURCE CONTROL BMPs, AS APPLICABLE		
1 Potential Sources of Runoff Pollutants	2 Permanent Controls—Show on WQMP Drawings	3 Permanent Controls—List in WQMP Table and Narrative	4 Operational BMPs—Include in WQMP Table and Narrative
<input type="checkbox"/> E. Pools, spas, ponds, decorative fountains, and other water features.	<input type="checkbox"/> Show location of water feature and a sanitary sewer cleanout in an accessible area within 10 feet. (Exception: Public pools must be plumbed according to County Department of Environmental Health Guidelines.)	If the Co-Permittee requires pools to be plumbed to the sanitary sewer, place a note on the plans and state in the narrative that this connection will be made according to local requirements.	<input type="checkbox"/> See applicable operational BMPs in “Guidelines for Maintaining Your Swimming Pool, Jacuzzi and Garden Fountain” at http://rcflood.org/stormwater/
<input type="checkbox"/> F. Food service	<input type="checkbox"/> For restaurants, grocery stores, and other food service operations, show location (indoors or in a covered area outdoors) of a floor sink or other area for cleaning floor mats, containers, and equipment. <input type="checkbox"/> On the drawing, show a note that this drain will be connected to a grease interceptor before discharging to the sanitary sewer.	<input type="checkbox"/> Describe the location and features of the designated cleaning area. <input type="checkbox"/> Describe the items to be cleaned in this facility and how it has been sized to insure that the largest items can be accommodated.	<input type="checkbox"/> See the brochure, “The Food Service Industry Best Management Practices for: Restaurants, Grocery Stores, Delicatessens and Bakeries” at http://rcflood.org/stormwater/ Provide this brochure to new site owners, lessees, and operators.
<input type="checkbox"/> G. Refuse areas	<input type="checkbox"/> Show where site refuse and recycled materials will be handled and stored for pickup. See local municipal requirements for sizes and other details of refuse areas. <input type="checkbox"/> If dumpsters or other receptacles are outdoors, show how the designated area will be covered, graded, and paved to prevent run-on and show locations of berms to prevent runoff from the area. <input type="checkbox"/> Any drains from dumpsters, compactors, and tallow bin areas shall be connected to a grease removal device before discharge to sanitary sewer.	<input type="checkbox"/> State how site refuse will be handled and provide supporting detail to what is shown on plans. <input type="checkbox"/> State that signs will be posted on or near dumpsters with the words “Do not dump hazardous materials here” or similar.	<input type="checkbox"/> State how the following will be implemented: Provide adequate number of receptacles. Inspect receptacles regularly; repair or replace leaky receptacles. Keep receptacles covered. Prohibit/prevent dumping of liquid or hazardous wastes. Post “no hazardous materials” signs. Inspect and pick up litter daily and clean up spills immediately. Keep spill control materials available on-site. See Fact Sheet SC-34, “Waste Handling and Disposal” in the CASQA Stormwater Quality Handbooks at www.cabmphandbooks.com

STORMWATER POLLUTANT SOURCES/SOURCE CONTROL CHECKLIST

IF THESE SOURCES WILL BE ON THE PROJECT SITE THEN YOUR WQMP SHOULD INCLUDE THESE SOURCE CONTROL BMPs, AS APPLICABLE		
1 Potential Sources of Runoff Pollutants	2 Permanent Controls—Show on WQMP Drawings	3 Permanent Controls—List in WQMP Table and Narrative	4 Operational BMPs—Include in WQMP Table and Narrative
<input type="checkbox"/> H. Industrial processes.	<input type="checkbox"/> Show process area.	<input type="checkbox"/> If industrial processes are to be located on site, state: “All process activities to be performed indoors. No processes to drain to exterior or to storm drain system.”	<input type="checkbox"/> See Fact Sheet SC-10, “Non-Stormwater Discharges” in the CASQA Stormwater Quality Handbooks at www.cabmphandbooks.com See the brochure “Industrial & Commercial Facilities Best Management Practices for: Industrial, Commercial Facilities” at http://rcflood.org/stormwater/

STORMWATER POLLUTANT SOURCES/SOURCE CONTROL CHECKLIST

IF THESE SOURCES WILL BE ON THE PROJECT SITE THEN YOUR WQMP SHOULD INCLUDE THESE SOURCE CONTROL BMPs, AS APPLICABLE		
1 Potential Sources of Runoff Pollutants	2 Permanent Controls—Show on WQMP Drawings	3 Permanent Controls—List in WQMP Table and Narrative	4 Operational BMPs—Include in WQMP Table and Narrative
<p><input type="checkbox"/> I. Outdoor storage of equipment or materials. (See rows J and K for source control measures for vehicle cleaning, repair, and maintenance.)</p>	<p><input type="checkbox"/> Show any outdoor storage areas, including how materials will be covered. Show how areas will be graded and bermed to prevent run-on or run-off from area.</p> <p><input type="checkbox"/> Storage of non-hazardous liquids shall be covered by a roof and/or drain to the sanitary sewer system, and be contained by berms, dikes, liners, or vaults.</p> <p><input type="checkbox"/> Storage of hazardous materials and wastes must be in compliance with the local hazardous materials ordinance and a Hazardous Materials Management Plan for the site.</p>	<p>Include a detailed description of materials to be stored, storage areas, and structural features to prevent pollutants from entering storm drains.</p> <p>Where appropriate, reference documentation of compliance with the requirements of Hazardous Materials Programs for:</p> <ul style="list-style-type: none"> ▪ Hazardous Waste Generation ▪ Hazardous Materials Release Response and Inventory ▪ California Accidental Release (CalARP) ▪ Aboveground Storage Tank ▪ Uniform Fire Code Article 80 Section 103(b) & (c) 1991 ▪ Underground Storage Tank <p>www.cchealth.org/groups/hazmat/</p>	<p><input type="checkbox"/> See the Fact Sheets SC-31, “Outdoor Liquid Container Storage” and SC-33, “Outdoor Storage of Raw Materials ” in the CASQA Stormwater Quality Handbooks at www.cabmphandbooks.com</p>

STORMWATER POLLUTANT SOURCES/SOURCE CONTROL CHECKLIST

IF THESE SOURCES WILL BE ON THE PROJECT SITE THEN YOUR WQMP SHOULD INCLUDE THESE SOURCE CONTROL BMPs, AS APPLICABLE		
1 Potential Sources of Runoff Pollutants	2 Permanent Controls—Show on WQMP Drawings	3 Permanent Controls—List in WQMP Table and Narrative	4 Operational BMPs—Include in WQMP Table and Narrative
<input type="checkbox"/> J. Vehicle and Equipment Cleaning	<input type="checkbox"/> Show on drawings as appropriate: (1) Commercial/industrial facilities having vehicle/equipment cleaning needs shall either provide a covered, bermed area for washing activities or discourage vehicle/equipment washing by removing hose bibs and installing signs prohibiting such uses. (2) Multi-dwelling complexes shall have a paved, bermed, and covered car wash area (unless car washing is prohibited on-site and hoses are provided with an automatic shut-off to discourage such use). (3) Washing areas for cars, vehicles, and equipment shall be paved, designed to prevent run-on to or runoff from the area, and plumbed to drain to the sanitary sewer. (4) Commercial car wash facilities shall be designed such that no runoff from the facility is discharged to the storm drain system. Wastewater from the facility shall discharge to the sanitary sewer, or a wastewater reclamation system shall be installed.	<input type="checkbox"/> If a car wash area is not provided, describe any measures taken to discourage on-site car washing and explain how these will be enforced.	Describe operational measures to implement the following (if applicable): <input type="checkbox"/> Washwater from vehicle and equipment washing operations shall not be discharged to the storm drain system. Refer to “Outdoor Cleaning Activities and Professional Mobile Service Providers” for many of the Potential Sources of Runoff Pollutants categories below. Brochure can be found at http://rcflood.org/stormwater/ <input type="checkbox"/> Car dealerships and similar may rinse cars with water only.

STORMWATER POLLUTANT SOURCES/SOURCE CONTROL CHECKLIST

IF THESE SOURCES WILL BE ON THE PROJECT SITE THEN YOUR WQMP SHOULD INCLUDE THESE SOURCE CONTROL BMPs, AS APPLICABLE		
1 Potential Sources of Runoff Pollutants	2 Permanent Controls—Show on WQMP Drawings	3 Permanent Controls—List in WQMP Table and Narrative	4 Operational BMPs—Include in WQMP Table and Narrative
<p><input type="checkbox"/> K. Vehicle/Equipment Repair and Maintenance</p>	<p><input type="checkbox"/> Accommodate all vehicle equipment repair and maintenance indoors. Or designate an outdoor work area and design the area to prevent run-on and runoff of stormwater.</p> <p><input type="checkbox"/> Show secondary containment for exterior work areas where motor oil, brake fluid, gasoline, diesel fuel, radiator fluid, acid-containing batteries or other hazardous materials or hazardous wastes are used or stored. Drains shall not be installed within the secondary containment areas.</p> <p><input type="checkbox"/> Add a note on the plans that states either (1) there are no floor drains, or (2) floor drains are connected to wastewater pretreatment systems prior to discharge to the sanitary sewer and an industrial waste discharge permit will be obtained.</p>	<p><input type="checkbox"/> State that no vehicle repair or maintenance will be done outdoors, or else describe the required features of the outdoor work area.</p> <p><input type="checkbox"/> State that there are no floor drains or if there are floor drains, note the agency from which an industrial waste discharge permit will be obtained and that the design meets that agency’s requirements.</p> <p><input type="checkbox"/> State that there are no tanks, containers or sinks to be used for parts cleaning or rinsing or, if there are, note the agency from which an industrial waste discharge permit will be obtained and that the design meets that agency’s requirements.</p>	<p>In the Stormwater Control Plan, note that all of the following restrictions apply to use the site:</p> <p><input type="checkbox"/> No person shall dispose of, nor permit the disposal, directly or indirectly of vehicle fluids, hazardous materials, or rinsewater from parts cleaning into storm drains.</p> <p><input type="checkbox"/> No vehicle fluid removal shall be performed outside a building, nor on asphalt or ground surfaces, whether inside or outside a building, except in such a manner as to ensure that any spilled fluid will be in an area of secondary containment. Leaking vehicle fluids shall be contained or drained from the vehicle immediately.</p> <p><input type="checkbox"/> No person shall leave unattended drip parts or other open containers containing vehicle fluid, unless such containers are in use or in an area of secondary containment.</p> <p>Refer to “Automotive Maintenance & Car Care Best Management Practices for Auto Body Shops, Auto Repair Shops, Car Dealerships, Gas Stations and Fleet Service Operations”. Brochure can be found at http://rcflood.org/stormwater/</p> <p>Refer to Outdoor Cleaning Activities and Professional Mobile Service Providers for many of the Potential Sources of Runoff Pollutants categories below. Brochure can be found at http://rcflood.org/stormwater/</p>

STORMWATER POLLUTANT SOURCES/SOURCE CONTROL CHECKLIST

IF THESE SOURCES WILL BE ON THE PROJECT SITE THEN YOUR WQMP SHOULD INCLUDE THESE SOURCE CONTROL BMPs, AS APPLICABLE		
1 Potential Sources of Runoff Pollutants	2 Permanent Controls—Show on WQMP Drawings	3 Permanent Controls—List in WQMP Table and Narrative	4 Operational BMPs—Include in WQMP Table and Narrative
<input type="checkbox"/> L. Fuel Dispensing Areas	<input type="checkbox"/> Fueling areas ⁶ shall have impermeable floors (i.e., portland cement concrete or equivalent smooth impervious surface) that are: a) graded at the minimum slope necessary to prevent ponding; and b) separated from the rest of the site by a grade break that prevents run-on of stormwater to the maximum extent practicable. <input type="checkbox"/> Fueling areas shall be covered by a canopy that extends a minimum of ten feet in each direction from each pump. [Alternative: The fueling area must be covered and the cover's minimum dimensions must be equal to or greater than the area within the grade break or fuel dispensing area ¹ .] The canopy [or cover] shall not drain onto the fueling area.		<input type="checkbox"/> The property owner shall dry sweep the fueling area routinely. <input type="checkbox"/> See the Fact Sheet SD-30 , “Fueling Areas” in the CASQA Stormwater Quality Handbooks at www.cabmphandbooks.com

⁶ The fueling area shall be defined as the area extending a minimum of 6.5 feet from the corner of each fuel dispenser or the length at which the hose and nozzle assembly may be operated plus a minimum of one foot, whichever is greater.

STORMWATER POLLUTANT SOURCES/SOURCE CONTROL CHECKLIST

IF THESE SOURCES WILL BE ON THE PROJECT SITE THEN YOUR WQMP SHOULD INCLUDE THESE SOURCE CONTROL BMPs, AS APPLICABLE		
1 Potential Sources of Runoff Pollutants	2 Permanent Controls—Show on WQMP Drawings	3 Permanent Controls—List in WQMP Table and Narrative	4 Operational BMPs—Include in WQMP Table and Narrative
<input type="checkbox"/> M. Loading Docks	<input type="checkbox"/> Show a preliminary design for the loading dock area, including roofing and drainage. Loading docks shall be covered and/or graded to minimize run-on to and runoff from the loading area. Roof downspouts shall be positioned to direct stormwater away from the loading area. Water from loading dock areas shall be drained to the sanitary sewer, or diverted and collected for ultimate discharge to the sanitary sewer. <input type="checkbox"/> Loading dock areas draining directly to the sanitary sewer shall be equipped with a spill control valve or equivalent device, which shall be kept closed during periods of operation. <input type="checkbox"/> Provide a roof overhang over the loading area or install door skirts (cowling) at each bay that enclose the end of the trailer.		<input type="checkbox"/> Move loaded and unloaded items indoors as soon as possible. <input type="checkbox"/> See Fact Sheet SC-30, “Outdoor Loading and Unloading,” in the CASQA Stormwater Quality Handbooks at www.cabmphandbooks.com

STORMWATER POLLUTANT SOURCES/SOURCE CONTROL CHECKLIST

IF THESE SOURCES WILL BE ON THE PROJECT SITE THEN YOUR WQMP SHOULD INCLUDE THESE SOURCE CONTROL BMPs, AS APPLICABLE		
1 Potential Sources of Runoff Pollutants	2 Permanent Controls—Show on WQMP Drawings	3 Permanent Controls—List in WQMP Table and Narrative	4 Operational BMPs—Include in WQMP Table and Narrative
<input type="checkbox"/> N. Fire Sprinkler Test Water		<input type="checkbox"/> Provide a means to drain fire sprinkler test water to the sanitary sewer.	<input type="checkbox"/> See the note in Fact Sheet SC-41, “Building and Grounds Maintenance,” in the CASQA Stormwater Quality Handbooks at www.cabmphandbooks.com
<p>O. Miscellaneous Drain or Wash Water or Other Sources</p> <input type="checkbox"/> Boiler drain lines <input type="checkbox"/> Condensate drain lines <input type="checkbox"/> Rooftop equipment <input type="checkbox"/> Drainage sumps <input checked="" type="checkbox"/> Roofing, gutters, and trim. <input type="checkbox"/> Other sources		<input type="checkbox"/> Boiler drain lines shall be directly or indirectly connected to the sanitary sewer system and may not discharge to the storm drain system. <input type="checkbox"/> Condensate drain lines may discharge to landscaped areas if the flow is small enough that runoff will not occur. Condensate drain lines may not discharge to the storm drain system. Rooftop equipment with potential to produce pollutants shall be roofed and/or have secondary containment. <input type="checkbox"/> Any drainage sumps on-site shall feature a sediment sump to reduce the quantity of sediment in pumped water. <input checked="" type="checkbox"/> Avoid roofing, gutters, and trim made of copper or other unprotected metals that may leach into runoff. Include controls for other sources as specified by local reviewer.	

STORMWATER POLLUTANT SOURCES/SOURCE CONTROL CHECKLIST

IF THESE SOURCES WILL BE ON THE PROJECT SITE THEN YOUR WQMP SHOULD INCLUDE THESE SOURCE CONTROL BMPs, AS APPLICABLE		
1 Potential Sources of Runoff Pollutants	2 Permanent Controls—Show on WQMP Drawings	3 Permanent Controls—List in WQMP Table and Narrative	4 Operational BMPs—Include in WQMP Table and Narrative
<input checked="" type="checkbox"/> P. Plazas, sidewalks, and parking lots.			<input checked="" type="checkbox"/> Sweep plazas, sidewalks, and parking lots regularly to prevent accumulation of litter and debris. Collect debris from pressure washing to prevent entry into the storm drain system. Collect washwater containing any cleaning agent or degreaser and discharge to the sanitary sewer not to a storm drain.

Appendix 9: O&M

Operation and Maintenance Plan and Documentation of Finance, Maintenance and Recording Mechanisms

Operations & Maintenance Responsibility for Treatment Control BMP's

The planned development will consist of 67 single-family residences, street improvements, and 2 onsite stormwater treatment areas (Bio-retention basins). They are at the intersection of Oliver Street and Brodiaea Avenue and between Lot 47 & 48. Offsite street improvements will be done on Oliver Street and Brodiaea Avenue in order to build out ultimate curb and gutter along the project frontage. All onsite runoff will flow to the south as per the existing drainage path.

BMP Required Maintenance	Frequency	Maintenance Requirements	Responsibility	Est. Annual (\$)**
Roof Drains/ Gutters	Before wet season, or significant rain event, or when needed	Roof Gutters shall be visually inspected for defects and possible leakage. Damage or defects found shall be corrected as soon as possible. Owners should avoid use of gutters, roofing, and trim made of copper so as to prevent the metal from leaching into runoff.	Individual Condo Owners	TBD
Self-Retaining/ Landscape Areas	Bi-Weekly	Mow, weed, trim and remove accumulation of trash debris and/or sediment. Retaining areas should be mowed at 4-6 inches in height if grass is proposed. Maintain landscaping using minimal pesticides	HOA	\$3,132
Extended Detention Basin	Ongoing including just before annual storm seasons & following rainfall events.	<ul style="list-style-type: none"> Maintain vegetation as needed. Use of fertilizers, pesticides and herbicides should be strongly avoided to ensure they don't contribute to water pollution. If appropriate native plant selections and other IPM methods are used, such products shouldn't be needed. If such projects are used: Care should be taken to avoid contact with the low-flow or other trenches, and the media filter in the bottom stage. Products shall be applied in accordance with their labeling, especially in relation to application to water, and in areas subjected to flooding. Fertilizers should not be applied within 15 days before, after, or during the rainy season. No ponded water should be present for more than 72 hours to avoid nuisance or vector problems. No algae formation should be visible. Correct problems as needed 	HOA	
	Annually. If possible, schedule These inspections before the beginning of the rain season to allow for any repairs to occur before rains occur	<ul style="list-style-type: none"> Remove debris and litter from the entire basin Inspect hydraulic and structural facilities. Examine the outlet for clogging, the embankment and spillway integrity, as well as damage to any structural element. Check for erosion, slumping and overgrowth. Repair as needed. Inspect sand media at the filter drain to verify it is allowing acceptable infiltration. Scarify top 3 inches by raking the filter drain's sand surface annually. Check the media filter underdrains (via the cleanout) for damage or clogging. Repair as needed. Remove accumulated sediment and debris from the forebay, and ensure that the notch weir is clear and will allow proper drainage. Check gravel filled low flow and collector trenches for sediment buildup and repair as needed. 	HOA	
	Every 5 years or sooner (depending on whether observed drain times to empty the basin are less than 72 hours)	Remove the top 3 inches of sand from the filter drain and backfill with 3 inches of new sand to return the sand layer to its original depth. When scarification or removal of the top 3 inches of sand is no longer effective, remove and replace sand filter layer.	HOA	

**Water Quality Management Plan (WQMP)
Tract 38237
Moreno Valley**

	Whenever substantial sediment accumulation has occurred.	Remove accumulated sediment from the bottom of the basin. Removal should extend to original basin depth.	HOA	
On-site Storm Drain inlets	During every scheduled maintenance check (per below), and as needed at other times following rainfall events.	Regular inspections and maintenance will be required to prevent the inlets from becoming more than 40% full. Two-person teams may be required to clean catch basins with vacor trucks. Arrangements must be made for proper disposal of collected wastes. Technical staff are required to detect and investigate illegal/illicit dumping violations.	HOA	\$1,600
Street Sweeping	Bi-weekly	Street sweeping will be conducted, to remove all debris from streets to prevent any clogging of site storm drains.	HOA	\$3,700

BMP's should start and be inspected prior to forecast rain, daily during extended rain events, after rain events, weekly during the rainy season, and at two-week intervals during the non-rainy season.

**Estimated Annual Fees taken from the Project's Budget Worksheet (DRAFT) for the State of California – Department of Real Estate prepared by Seabreeze Management Company, Inc. - Contact: Brandon Tryon and California Stormwater BMP Handbook January 2003 Extended Detention Basin TC-22

Funding

Funding for Ongoing Maintenance will be provided by:

Future Homeowner's Association (HOA)

Upon formation of the HOA, financial and operational maintenance responsibilities will be transferred from the owner, Century Communities, to the HOA through a Covenant & Agreement. A budget for ongoing maintenance of all BMP's will be created by the HOA to ensure responsibilities delegated by the Covenant & Agreement are upheld.

Extended Detention Basin Site - Maintenance Summary Form

Property Owner – DR Horton
2280 Warlow Circle, Suite 200 Corona, CA 92880
Phone: 951-272-9000

Date:	Inspector Name:	Basin:
Maintenance Performed:		
Date:	Inspector Name:	Basin:
Maintenance Performed:		
Date:	Inspector Name:	Basin:
Maintenance Performed:		
Date:	Inspector Name:	Basin:
Maintenance Performed:		
Date:	Inspector Name:	Basin:
Maintenance Performed:		
Date:	Inspector Name:	Basin:
Maintenance Performed:		
Date:	Inspector Name:	Basin:
Maintenance Performed:		
Date:	Inspector Name:	Basin:
Maintenance Performed:		
Date:	Inspector Name:	Basin:
Maintenance Performed:		
Date:	Inspector Name:	Basin:
Maintenance Performed:		
Date:	Inspector Name:	Basin:
Maintenance Performed:		
Date:	Inspector Name:	Basin:
Maintenance Performed:		

Storm Drain Inlet - Maintenance Summary Form

Property Owner – DR Horton
2280 Warlow Circle, Suite 200 Corona, CA 92880
Phone: 951-272-9000

Date:	Inspector Name:	Inlet:
Maintenance Performed:		
Date:	Inspector Name:	Inlet :
Maintenance Performed:		
Date:	Inspector Name:	Inlet :
Maintenance Performed:		
Date:	Inspector Name:	Inlet :
Maintenance Performed:		
Date:	Inspector Name:	Inlet :
Maintenance Performed:		
Date:	Inspector Name:	Inlet :
Maintenance Performed:		
Date:	Inspector Name:	Inlet :
Maintenance Performed:		
Date:	Inspector Name:	Inlet :
Maintenance Performed:		
Date:	Inspector Name:	Inlet :
Maintenance Performed:		
Date:	Inspector Name:	Inlet :
Maintenance Performed:		
Date:	Inspector Name:	Inlet :
Maintenance Performed:		
Date:	Inspector Name:	Inlet :
Maintenance Performed:		

Street Sweeping - Maintenance Summary Form

Property Owner – DR Horton
2280 Warlow Circle, Suite 200 Corona, CA 92880
Phone: 951-272-9000

Water Quality Management Plan (WQMP)
Tract 38237
Moreno Valley

Date:	Inspector Name:	Street:
Maintenance Performed:		
Date:	Inspector Name:	Street:
Maintenance Performed:		
Date:	Inspector Name:	Street:
Maintenance Performed:		
Date:	Inspector Name:	Street:
Maintenance Performed:		
Date:	Inspector Name:	Street:
Maintenance Performed:		
Date:	Inspector Name:	Street:
Maintenance Performed:		
Date:	Inspector Name:	Street:
Maintenance Performed:		
Date:	Inspector Name:	Street:
Maintenance Performed:		
Date:	Inspector Name:	Street:
Maintenance Performed:		
Date:	Inspector Name:	Street:
Maintenance Performed:		
Date:	Inspector Name:	Street:
Maintenance Performed:		
Date:	Inspector Name:	Street:
Maintenance Performed:		

Property Owner – DR Horton
2280 Warlow Circle, Suite 200 Corona, CA 92880
Phone: 951-272-9000

Appendix 10: Educational Materials

BMP Fact Sheets, Maintenance Guidelines and Other End-User BMP Information



Design Considerations

- Soil for Infiltration
- Tributary Area
- Slope
- Aesthetics
- Environmental Side-effects

Description

The bioretention best management practice (BMP) functions as a soil and plant-based filtration device that removes pollutants through a variety of physical, biological, and chemical treatment processes. These facilities normally consist of a grass buffer strip, sand bed, ponding area, organic layer or mulch layer, planting soil, and plants. The runoff's velocity is reduced by passing over or through buffer strip and subsequently distributed evenly along a ponding area. Exfiltration of the stored water in the bioretention area planting soil into the underlying soils occurs over a period of days.

California Experience

None documented. Bioretention has been used as a stormwater BMP since 1992. In addition to Prince George's County, MD and Alexandria, VA, bioretention has been used successfully at urban and suburban areas in Montgomery County, MD; Baltimore County, MD; Chesterfield County, VA; Prince William County, VA; Smith Mountain Lake State Park, VA; and Cary, NC.

Advantages

- Bioretention provides stormwater treatment that enhances the quality of downstream water bodies by temporarily storing runoff in the BMP and releasing it over a period of four days to the receiving water (EPA, 1999).
- The vegetation provides shade and wind breaks, absorbs noise, and improves an area's landscape.

Limitations

- The bioretention BMP is not recommended for areas with slopes greater than 20% or where mature tree removal would

Targeted Constituents

<input checked="" type="checkbox"/>	Sediment	■
<input checked="" type="checkbox"/>	Nutrients	▲
<input checked="" type="checkbox"/>	Trash	■
<input checked="" type="checkbox"/>	Metals	■
<input checked="" type="checkbox"/>	Bacteria	■
<input checked="" type="checkbox"/>	Oil and Grease	■
<input checked="" type="checkbox"/>	Organics	■

Legend (Removal Effectiveness)

- Low
- High
- ▲ Medium



be required since clogging may result, particularly if the BMP receives runoff with high sediment loads (EPA, 1999).

- Bioretention is not a suitable BMP at locations where the water table is within 6 feet of the ground surface and where the surrounding soil stratum is unstable.
- By design, bioretention BMPs have the potential to create very attractive habitats for mosquitoes and other vectors because of highly organic, often heavily vegetated areas mixed with shallow water.
- In cold climates the soil may freeze, preventing runoff from infiltrating into the planting soil.

Design and Sizing Guidelines

- The bioretention area should be sized to capture the design storm runoff.
- In areas where the native soil permeability is less than 0.5 in/hr an underdrain should be provided.
- Recommended minimum dimensions are 15 feet by 40 feet, although the preferred width is 25 feet. Excavated depth should be 4 feet.
- Area should drain completely within 72 hours.
- Approximately 1 tree or shrub per 50 ft² of bioretention area should be included.
- Cover area with about 3 inches of mulch.

Construction/Inspection Considerations

Bioretention area should not be established until contributing watershed is stabilized.

Performance

Bioretention removes stormwater pollutants through physical and biological processes, including adsorption, filtration, plant uptake, microbial activity, decomposition, sedimentation and volatilization (EPA, 1999). Adsorption is the process whereby particulate pollutants attach to soil (e.g., clay) or vegetation surfaces. Adequate contact time between the surface and pollutant must be provided for in the design of the system for this removal process to occur. Thus, the infiltration rate of the soils must not exceed those specified in the design criteria or pollutant removal may decrease. Pollutants removed by adsorption include metals, phosphorus, and hydrocarbons. Filtration occurs as runoff passes through the bioretention area media, such as the sand bed, ground cover, and planting soil.

Common particulates removed from stormwater include particulate organic matter, phosphorus, and suspended solids. Biological processes that occur in wetlands result in pollutant uptake by plants and microorganisms in the soil. Plant growth is sustained by the uptake of nutrients from the soils, with woody plants locking up these nutrients through the seasons. Microbial activity within the soil also contributes to the removal of nitrogen and organic matter. Nitrogen is removed by nitrifying and denitrifying bacteria, while aerobic bacteria are responsible for the decomposition of the organic matter. Microbial processes require oxygen and can result in depleted oxygen levels if the bioretention area is not adequately

aerated. Sedimentation occurs in the swale or ponding area as the velocity slows and solids fall out of suspension.

The removal effectiveness of bioretention has been studied during field and laboratory studies conducted by the University of Maryland (Davis et al, 1998). During these experiments, synthetic stormwater runoff was pumped through several laboratory and field bioretention areas to simulate typical storm events in Prince George's County, MD. Removal rates for heavy metals and nutrients are shown in Table 1.

Pollutant	Removal Rate
Total Phosphorus	70-83%
Metals (Cu, Zn, Pb)	93-98%
TKN	68-80%
Total Suspended Solids	90%
Organics	90%
Bacteria	90%

Results for both the laboratory and field experiments were similar for each of the pollutants analyzed. Doubling or halving the influent pollutant levels had little effect on the effluent pollutants concentrations (Davis et al, 1998).

The microbial activity and plant uptake occurring in the bioretention area will likely result in higher removal rates than those determined for infiltration BMPs.

Siting Criteria

Bioretention BMPs are generally used to treat stormwater from impervious surfaces at commercial, residential, and industrial areas (EPA, 1999). Implementation of bioretention for stormwater management is ideal for median strips, parking lot islands, and swales. Moreover, the runoff in these areas can be designed to either divert directly into the bioretention area or convey into the bioretention area by a curb and gutter collection system.

The best location for bioretention areas is upland from inlets that receive sheet flow from graded areas and at areas that will be excavated (EPA, 1999). In order to maximize treatment effectiveness, the site must be graded in such a way that minimizes erosive conditions as sheet flow is conveyed to the treatment area. Locations where a bioretention area can be readily incorporated into the site plan without further environmental damage are preferred. Furthermore, to effectively minimize sediment loading in the treatment area, bioretention only should be used in stabilized drainage areas.

Additional Design Guidelines

The layout of the bioretention area is determined after site constraints such as location of utilities, underlying soils, existing vegetation, and drainage are considered (EPA, 1999). Sites with loamy sand soils are especially appropriate for bioretention because the excavated soil can be backfilled and used as the planting soil, thus eliminating the cost of importing planting soil.

The use of bioretention may not be feasible given an unstable surrounding soil stratum, soils with clay content greater than 25 percent, a site with slopes greater than 20 percent, and/or a site with mature trees that would be removed during construction of the BMP.

Bioretention can be designed to be off-line or on-line of the existing drainage system (EPA, 1999). The drainage area for a bioretention area should be between 0.1 and 0.4 hectares (0.25 and 1.0 acres). Larger drainage areas may require multiple bioretention areas. Furthermore, the maximum drainage area for a bioretention area is determined by the expected rainfall intensity and runoff rate. Stabilized areas may erode when velocities are greater than 5 feet per second (1.5 meter per second). The designer should determine the potential for erosive conditions at the site.

The size of the bioretention area, which is a function of the drainage area and the runoff generated from the area is sized to capture the water quality volume.

The recommended minimum dimensions of the bioretention area are 15 feet (4.6 meters) wide by 40 feet (12.2 meters) long, where the minimum width allows enough space for a dense, randomly-distributed area of trees and shrubs to become established. Thus replicating a natural forest and creating a microclimate, thereby enabling the bioretention area to tolerate the effects of heat stress, acid rain, runoff pollutants, and insect and disease infestations which landscaped areas in urban settings typically are unable to tolerate. The preferred width is 25 feet (7.6 meters), with a length of twice the width. Essentially, any facilities wider than 20 feet (6.1 meters) should be twice as long as they are wide, which promotes the distribution of flow and decreases the chances of concentrated flow.

In order to provide adequate storage and prevent water from standing for excessive periods of time the ponding depth of the bioretention area should not exceed 6 inches (15 centimeters). Water should not be left to stand for more than 72 hours. A restriction on the type of plants that can be used may be necessary due to some plants' water intolerance. Furthermore, if water is left standing for longer than 72 hours mosquitoes and other insects may start to breed.

The appropriate planting soil should be backfilled into the excavated bioretention area. Planting soils should be sandy loam, loamy sand, or loam texture with a clay content ranging from 10 to 25 percent.

Generally the soil should have infiltration rates greater than 0.5 inches (1.25 centimeters) per hour, which is typical of sandy loams, loamy sands, or loams. The pH of the soil should range between 5.5 and 6.5, where pollutants such as organic nitrogen and phosphorus can be adsorbed by the soil and microbial activity can flourish. Additional requirements for the planting soil include a 1.5 to 3 percent organic content and a maximum 500 ppm concentration of soluble salts.

Soil tests should be performed for every 500 cubic yards (382 cubic meters) of planting soil, with the exception of pH and organic content tests, which are required only once per bioretention area (EPA, 1999). Planting soil should be 4 inches (10.1 centimeters) deeper than the bottom of the largest root ball and 4 feet (1.2 meters) altogether. This depth will provide adequate soil for the plants' root systems to become established, prevent plant damage due to severe wind, and provide adequate moisture capacity. Most sites will require excavation in order to obtain the recommended depth.

Planting soil depths of greater than 4 feet (1.2 meters) may require additional construction practices such as shoring measures (EPA, 1999). Planting soil should be placed in 18 inches or greater lifts and lightly compacted until the desired depth is reached. Since high canopy trees may be destroyed during maintenance the bioretention area should be vegetated to resemble a terrestrial forest community ecosystem that is dominated by understory trees. Three species each of both trees and shrubs are recommended to be planted at a rate of 2500 trees and shrubs per hectare (1000 per acre). For instance, a 15 foot (4.6 meter) by 40 foot (12.2 meter) bioretention area (600 square feet or 55.75 square meters) would require 14 trees and shrubs. The shrub-to-tree ratio should be 2:1 to 3:1.

Trees and shrubs should be planted when conditions are favorable. Vegetation should be watered at the end of each day for fourteen days following its planting. Plant species tolerant of pollutant loads and varying wet and dry conditions should be used in the bioretention area.

The designer should assess aesthetics, site layout, and maintenance requirements when selecting plant species. Adjacent non-native invasive species should be identified and the designer should take measures, such as providing a soil breach to eliminate the threat of these species invading the bioretention area. Regional landscaping manuals should be consulted to ensure that the planting of the bioretention area meets the landscaping requirements established by the local authorities. The designers should evaluate the best placement of vegetation within the bioretention area. Plants should be placed at irregular intervals to replicate a natural forest. Trees should be placed on the perimeter of the area to provide shade and shelter from the wind. Trees and shrubs can be sheltered from damaging flows if they are placed away from the path of the incoming runoff. In cold climates, species that are more tolerant to cold winds, such as evergreens, should be placed in windier areas of the site.

Following placement of the trees and shrubs, the ground cover and/or mulch should be established. Ground cover such as grasses or legumes can be planted at the beginning of the growing season. Mulch should be placed immediately after trees and shrubs are planted. Two to 3 inches (5 to 7.6 cm) of commercially-available fine shredded hardwood mulch or shredded hardwood chips should be applied to the bioretention area to protect from erosion.

Maintenance

The primary maintenance requirement for bioretention areas is that of inspection and repair or replacement of the treatment area's components. Generally, this involves nothing more than the routine periodic maintenance that is required of any landscaped area. Plants that are appropriate for the site, climatic, and watering conditions should be selected for use in the bioretention cell. Appropriately selected plants will aide in reducing fertilizer, pesticide, water, and overall maintenance requirements. Bioretention system components should blend over time through plant and root growth, organic decomposition, and the development of a natural

soil horizon. These biologic and physical processes over time will lengthen the facility's life span and reduce the need for extensive maintenance.

Routine maintenance should include a biannual health evaluation of the trees and shrubs and subsequent removal of any dead or diseased vegetation (EPA, 1999). Diseased vegetation should be treated as needed using preventative and low-toxic measures to the extent possible. BMPs have the potential to create very attractive habitats for mosquitoes and other vectors because of highly organic, often heavily vegetated areas mixed with shallow water. Routine inspections for areas of standing water within the BMP and corrective measures to restore proper infiltration rates are necessary to prevent creating mosquito and other vector habitat. In addition, bioretention BMPs are susceptible to invasion by aggressive plant species such as cattails, which increase the chances of water standing and subsequent vector production if not routinely maintained.

In order to maintain the treatment area's appearance it may be necessary to prune and weed. Furthermore, mulch replacement is suggested when erosion is evident or when the site begins to look unattractive. Specifically, the entire area may require mulch replacement every two to three years, although spot mulching may be sufficient when there are random void areas. Mulch replacement should be done prior to the start of the wet season.

New Jersey's Department of Environmental Protection states in their bioretention systems standards that accumulated sediment and debris removal (especially at the inflow point) will normally be the primary maintenance function. Other potential tasks include replacement of dead vegetation, soil pH regulation, erosion repair at inflow points, mulch replenishment, unclogging the underdrain, and repairing overflow structures. There is also the possibility that the cation exchange capacity of the soils in the cell will be significantly reduced over time. Depending on pollutant loads, soils may need to be replaced within 5-10 years of construction (LID, 2000).

Cost

Construction Cost

Construction cost estimates for a bioretention area are slightly greater than those for the required landscaping for a new development (EPA, 1999). A general rule of thumb (Coffman, 1999) is that residential bioretention areas average about \$3 to \$4 per square foot, depending on soil conditions and the density and types of plants used. Commercial, industrial and institutional site costs can range between \$10 to \$40 per square foot, based on the need for control structures, curbing, storm drains and underdrains.

Retrofitting a site typically costs more, averaging \$6,500 per bioretention area. The higher costs are attributed to the demolition of existing concrete, asphalt, and existing structures and the replacement of fill material with planting soil. The costs of retrofitting a commercial site in Maryland, Kettering Development, with 15 bioretention areas were estimated at \$111,600.

In any bioretention area design, the cost of plants varies substantially and can account for a significant portion of the expenditures. While these cost estimates are slightly greater than those of typical landscaping treatment (due to the increased number of plantings, additional soil excavation, backfill material, use of underdrains etc.), those landscaping expenses that would be required regardless of the bioretention installation should be subtracted when determining the net cost.

Perhaps of most importance, however, the cost savings compared to the use of traditional structural stormwater conveyance systems makes bioretention areas quite attractive financially. For example, the use of bioretention can decrease the cost required for constructing stormwater conveyance systems at a site. A medical office building in Maryland was able to reduce the amount of storm drain pipe that was needed from 800 to 230 feet - a cost savings of \$24,000 (PGDER, 1993). And a new residential development spent a total of approximately \$100,000 using bioretention cells on each lot instead of nearly \$400,000 for the traditional stormwater ponds that were originally planned (Rappahanock,). Also, in residential areas, stormwater management controls become a part of each property owner's landscape, reducing the public burden to maintain large centralized facilities.

Maintenance Cost

The operation and maintenance costs for a bioretention facility will be comparable to those of typical landscaping required for a site. Costs beyond the normal landscaping fees will include the cost for testing the soils and may include costs for a sand bed and planting soil.

References and Sources of Additional Information

Coffman, L.S., R. Goo and R. Frederick, 1999: Low impact development: an innovative alternative approach to stormwater management. Proceedings of the 26th Annual Water Resources Planning and Management Conference ASCE, June 6-9, Tempe, Arizona.

Davis, A.P., Shokouhian, M., Sharma, H. and Minami, C., "Laboratory Study of Biological Retention (Bioretention) for Urban Stormwater Management," *Water Environ. Res.*, 73(1), 5-14 (2001).

Davis, A.P., Shokouhian, M., Sharma, H., Minami, C., and Winogradoff, D. "Water Quality Improvement through Bioretention: Lead, Copper, and Zinc," *Water Environ. Res.*, accepted for publication, August 2002.

Kim, H., Seagren, E.A., and Davis, A.P., "Engineered Bioretention for Removal of Nitrate from Stormwater Runoff," *WEFTEC 2000 Conference Proceedings on CDROM Research Symposium, Nitrogen Removal*, Session 19, Anaheim CA, October 2000.

Hsieh, C.-h. and Davis, A.P. "Engineering Bioretention for Treatment of Urban Stormwater Runoff," *Watersheds 2002, Proceedings on CDROM Research Symposium*, Session 15, Ft. Lauderdale, FL, Feb. 2002.

Prince George's County Department of Environmental Resources (PGDER), 1993. Design Manual for Use of *Bioretention in Stormwater Management*. Division of Environmental Management, Watershed Protection Branch. Landover, MD.

U.S. EPA Office of Water, 1999. Stormwater Technology Fact Sheet: Bioretention. EPA 832-F-99-012.

Weinstein, N. Davis, A.P. and Veeramachaneni, R. "Low Impact Development (LID) Stormwater Management Approach for the Control of Diffuse Pollution from Urban Roadways," *5th International Conference Diffuse/Nonpoint Pollution and Watershed Management Proceedings*, C.S. Melching and Emre Alp, Eds. 2001 International Water Association

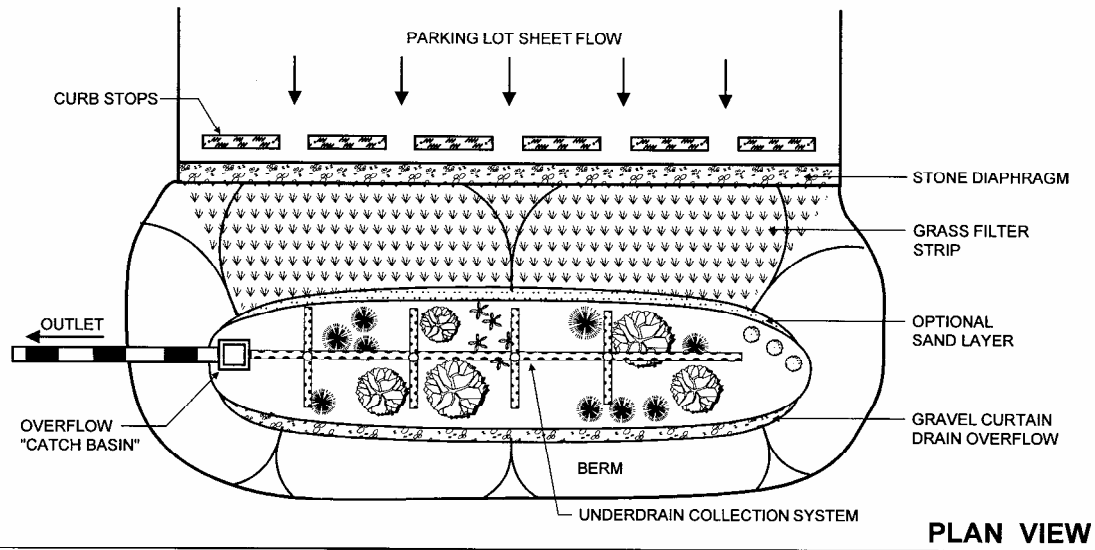

PLAN VIEW

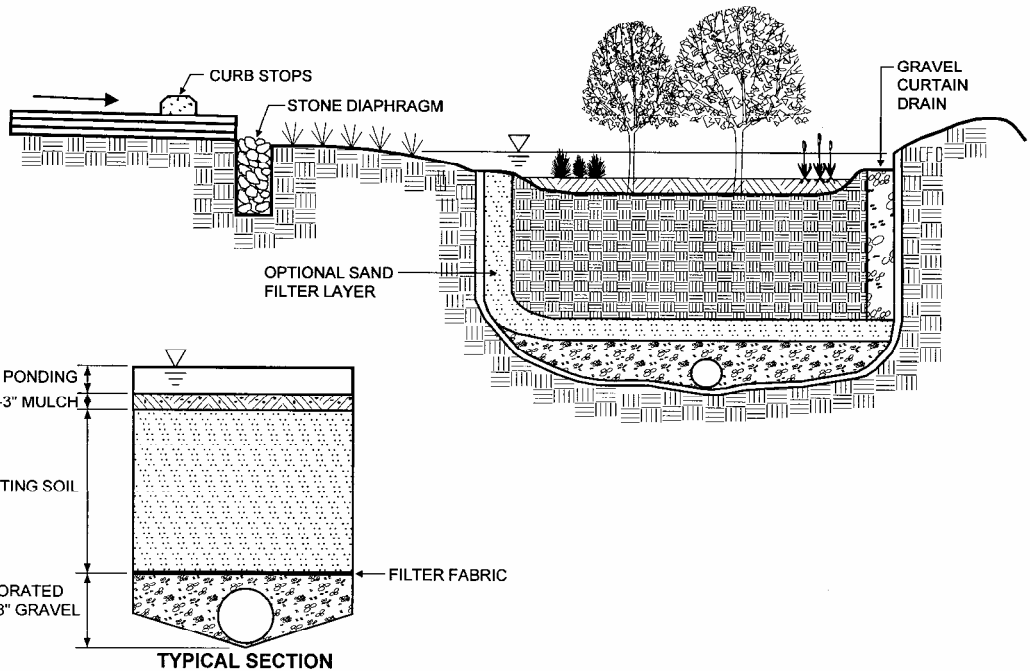

PROFILE

Schematic of a Bioretention Facility (MDE, 2000)